

Solaris 7980g

Area-Imaging Vertical Slot Scanner



User Guide

Disclaimer

Honeywell International Inc. (“HII”) reserves the right to make changes in specifications and other information contained in this document without prior notice, and the reader should in all cases consult HII to determine whether any such changes have been made. The information in this publication does not represent a commitment on the part of HII.

HII shall not be liable for technical or editorial errors or omissions contained herein; nor for incidental or consequential damages resulting from the furnishing, performance, or use of this material. HII disclaims all responsibility for the selection and use of software and/or hardware to achieve intended results.

This document contains proprietary information that is protected by copyright. All rights are reserved. No part of this document may be photocopied, reproduced, or translated into another language without the prior written consent of HII.

Copyright © 2015-2018 Honeywell International Inc. All rights reserved.

Web Address: www.honeywellaidc.com

Other product names or marks mentioned in this document may be trademarks or registered trademarks of other companies and are the property of their respective owners.

Microsoft® Windows® and the Windows logo are trademarks or registered trademarks of Microsoft Corporation.

Checkpoint® is a registered trademark of Checkpoint Systems, Inc.

Sensormatic® is a registered trademark of Tyco Retail Solutions.

Other product names or marks mentioned in this document may be trademarks or registered trademarks of other companies and are the property of their respective owners.

For patent information, refer to www.hsmpats.com.

TABLE OF CONTENTS

Customer Support	xi
Technical Assistance	xi
Product Service and Repair	xi
Limited Warranty	xi
Chapter 1 - Get Started	1
About This Manual.....	1
Unpack Your Device.....	1
Connect the Device.....	1
Connect with USB.....	1
Connect with Keyboard Wedge	2
Connect with RS232 Serial Port	5
Connect with RS485.....	6
Connect EAS	7
Checkpoint®	8
Sensormatic®	8
Connect Auxiliary Scanner	8
Button Functionality.....	10
Beeper Volume Adjustment.....	10
Beeper Frequency Adjustment.....	11
Reading Techniques.....	11
Menu Bar Code Security Settings.....	11
Set Custom Defaults	11
Reset the Custom Defaults.....	12

Chapter 2 - Program the Interface..... 13

Introduction	13
Program the Interface - Plug and Play	13
Keyboard Wedge	13
Laptop Direct Connect	14
RS232 Serial Port.....	14
RS485.....	14
RS485 Packet Mode.....	15
USB IBM SurePos	16
USB PC or Macintosh Keyboard	16
USB HID.....	17
USB Serial.....	17
CTS/RTS Emulation.....	17
ACK/NAK Mode.....	18
Verifone [®] Ruby Terminal Default Settings	18
Gilbarco [®] Terminal Default Settings.....	18
Wincor Nixdorf Terminal Default Settings.....	19
Wincor Nixdorf Beetle [™] Terminal Default Settings.....	19
Wincor Nixdorf RS232 Mode A.....	19
Keyboard Country Layout.....	20
Keyboard Style	27
Keyboard Conversion	28
Control Character Output.....	29
Keyboard Modifiers.....	29
RS232 Modifiers	31
RS232 Baud Rate	31
RS232 Word Length: Data Bits, Stop Bits, and Parity	32
RS232 Receiver Time-Out	33
RS232 Handshaking.....	33
RS232 Timeout.....	34
XON/XOFF.....	34

ACK/NAK.....34

Chapter 3 - Input/Output Settings37

Power Up Beeper37

Beep on BEL Character37

Good Read and Error Indicators.....38

 Beeper – Good Read38

 Beeper Volume – Good Read38

 Beeper Pitch – Good Read38

 Beeper Pitch – Error39

 Beeper Duration – Good Read.....39

 LED – Good Read.....40

 Number of Beeps – Good Read40

 Number of Beeps – Error.....40

 Good Read Delay.....40

 User-Specified Good Read Delay41

Serial Trigger Mode41

 Read Time-Out.....41

Presentation Mode42

 Presentation Idle Mode42

 Presentation Sleep Mode43

 LED Illumination - Presentation Mode.....44

 Presentation LED Behavior after Decode.....44

 Presentation Sensitivity.....45

 Presentation Centering45

Streaming Presentation™ Mode.....47

Mobile Phone Read Mode47

Poor Quality PDF Codes48

Poor Quality Code Enhanced Mode48

Reread Delay.....48

User-Specified Reread Delay.....49

Illumination Lights.....49

Centering.....49

Preferred Symbology	51
High Priority Symbology	52
Low Priority Symbology	52
Preferred Symbology Time-out.....	52
Preferred Symbology Default	53
Character Activation Mode	53
Activation Character	53
End Character Activation After Good Read.....	53
Character Activation LED Timeout.....	54
Character Deactivation Mode.....	54
Deactivation Character	55
Output Sequence Overview	55
Output Sequence Editor	55
To Add an Output Sequence	55
Output Sequence Editor Commands.....	56
Enter Output Sequence.....	59
Partial Sequence	59
No Read	62
Video Reverse	62
Working Orientation	63

Chapter 4 - Data Edit **65**

Prefix/Suffix Overview	65
To Add a Prefix or Suffix:.....	66
Clear One or All Prefixes or Suffixes	66
Add a Carriage Return Suffix to All Symbologies	67
Prefix Selections.....	67
Suffix Selections.....	67
Function Code Transmit.....	68
Intercharacter, Interfunction, and Intermessage Delays.....	68
Intercharacter Delay	69
User Specified Intercharacter Delay.....	69
Interfunction Delay	70

Intermessage Delay	70
Chapter 5 - Data Format	71
Data Format Editor Introduction	71
Show Data Format	72
Add a Data Format	72
Other Programming Selections	73
Terminal ID Table	74
Data Format Editor Commands	74
Move Commands	79
Search Commands	81
Miscellaneous Commands	83
Data Formatter	86
Data Format Non-Match Error Tone	87
Primary/Alternate Data Formats	88
Single Scan Data Format Change	88
Chapter 6 - Symbologies	91
All Symbologies	92
Message Length Description	92
Codabar	92
Codabar Concatenation	94
Codabar Redundancy	94
Code 39	95
Code 32 Pharmaceutical (PARAF)	97
Full ASCII	98
Code 39 Code Page	98
Interleaved 2 of 5	99
NEC 2 of 5	100
Code 93	102
Code 93 Append	102
Code 93 Code Page	103
Straight 2 of 5 Industrial (three-bar start/stop)	103

Straight 2 of 5 IATA (two-bar start/stop).....	104
Matrix 2 of 5.....	105
Code 11.....	106
Code 128.....	107
ISBT 128 Concatenation	108
Code 128 Code Page	109
GS1-128	109
Telepen.....	110
UPC-A.....	111
UPC-A/EAN-13 with Extended Coupon Code.....	114
Coupon GS1 DataBar Output	115
UPC-E0	115
UPC-E1	118
EAN/JAN-13	118
ISBN Translate.....	125
EAN/JAN-8.....	125
MSI.....	127
GS1 DataBar Omnidirectional.....	129
GS1 DataBar Limited	129
GS1 DataBar Expanded	130
Trioptic Code.....	131
Codablock A	131
Codablock F	132
Label Code.....	133
PDF417	133
MacroPDF417	134
MicroPDF417	134
GS1 Composite Codes	135
UPC/EAN Version	136
GS1 Emulation.....	136
TCIF Linked Code 39 (TLC39)	137

QR Code	138
QR Code Page	139
Data Matrix	139
Data Matrix Code Page.....	141
MaxiCode.....	141
Aztec Code	142
Aztec Code Page	143
Chinese Sensible (Han Xin) Code.....	143
Postal Codes - 2D.....	144
Single 2D Postal Codes:.....	144
Combination 2D Postal Codes:.....	145
Postal Codes - Linear	149
China Post (Hong Kong 2 of 5).....	149
Korea Post.....	150

Chapter 7 - EAS Settings 151

EAS Considerations	151
EAS Deactivation.....	151
EAS Deactivation Zone.....	152
EAS Deactivation Range.....	152
Sensormatic	152
Checkpoint.....	153
EAS Controller Settings	153
EAS Controller	153
EAS Mode of Operation	153
EAS Interlocked Duration Timeout.....	154

Chapter 8 - Program an Auxiliary Scanner 155

Introduction.....	155
Connect by USB Serial	155
Connect by USB Keyboard.....	155

Chapter 9 - Imaging Commands157

Single-Use Basis	157
Command Syntax	157
Image Snap - IMGSNP.....	158
IMGSNP Modifiers	158
Image Ship - IMGSHIP	161
IMGSHIP Modifiers	162
Image Size Compatibility	170
Intelligent Signature Capture - IMGBOX	171
Signature Capture Optimize.....	171
IMGBOX Modifiers	172

Chapter 10 - Utilities177

Add a Test Code I.D. Prefix to All Symbologies	177
Show Decoder Revision.....	177
Show Scan Driver Revision.....	177
Show Software Revision.....	178
Show Data Format.....	178
Test Menu	178
TotalFreedom.....	178
Application Plug-Ins (Apps)	179
EZConfig Cloud for Scanning Introduction	179
EZConfig Cloud for Scanning Operations.....	179
Install EZConfig Cloud for Scanning.....	180
Reset the Factory Defaults.....	180

Chapter 11 - Serial Programming Commands183

Conventions.....	183
Menu Command Syntax	183
Query Commands.....	184
Trigger Commands.....	186
Resetting the Custom Defaults.....	187

Menu Commands	187
Chapter 12 - Product Specifications.....	209
Solaris 7980g Scanner Product Specifications	209
Depth of Field Charts	210
Typical Performance.....	210
Guaranteed Performance.....	211
Standard Connector Pinouts.....	211
Keyboard Wedge	212
Serial Output	212
RS485 Output	212
USB.....	213
EAS	213
USB Auxiliary Scanner - Solaris end.....	214
Chapter 13 - Maintenance and Troubleshooting	215
Repairs.....	215
Maintenance.....	215
Cleaning the Scanner	215
Cleaning the Window	215
Inspecting Cords and Connectors	216
Replacing Cables	216
Replacing the Interface Cable.....	216
Replacing an EAS Cable	217
Troubleshooting.....	218
Appendix A - Reference Charts.....	221
Symbology Charts.....	221
Linear Symbologies	221
2D Symbologies	222
Postal Symbologies	223
ASCII Conversion Chart (Code Page 1252)	224
Lower ASCII Reference Table.....	225

ISO 2022/ISO 646 Character Replacements.....	228
Keyboard Key References	231
Sample Symbols.....	233
Programming Chart.....	235

Customer Support

Technical Assistance

If you need assistance installing or troubleshooting your device, please contact us by using one of the methods below:

Knowledge Base: www.hsmknowledgebase.com

Our Knowledge Base provides thousands of immediate solutions. If the Knowledge Base cannot help, our Technical Support Portal (see below) provides an easy way to report your problem or ask your question.

Technical Support Portal: www.hsmsupportportal.com

The Technical Support Portal not only allows you to report your problem, but it also provides immediate solutions to your technical issues by searching our Knowledge Base. With the Portal, you can submit and track your questions online and send and receive attachments.

Web form: www.hsmcontactsupport.com

You can contact our technical support team directly by filling out our online support form. Enter your contact details and the description of the question/problem.

Telephone: www.honeywellaidc.com/locations

For our latest contact information, please check our website at the link above.

Product Service and Repair

Honeywell International Inc. provides service for all of its products through service centers throughout the world. To obtain warranty or non-warranty service, please visit www.honeywellaidc.com and select Support > Contact Service and Repair to see your region's instructions on how to obtain a Return Material Authorization number (RMA #). You should do this prior to returning the product.

Limited Warranty

Refer to www.honeywellaidc.com/warranty_information for your product's warranty information.

About This Manual

This User's Guide provides installation and programming instructions for the Solaris 7980g area-imaging vertical slot scanners. Product specifications, dimensions, warranty, and customer support information are also included.

Honeywell bar code scanners are factory programmed for the most common terminal and communications settings. If you need to change these settings, programming is accomplished by scanning the bar codes in this guide.

An asterisk (*) next to an option indicates the default setting.

Unpack Your Device

After you open the shipping carton containing the product, take the following steps:

- Check for damage during shipment. Report damage immediately to the carrier who delivered the carton.
- Make sure the items in the carton match your order.
- Save the shipping container for later storage or shipping.

Connect the Device

Connect with USB

The scanner can be connected to the USB port of a computer.

1. Remove the back cover and feed the interface cable through to the device.

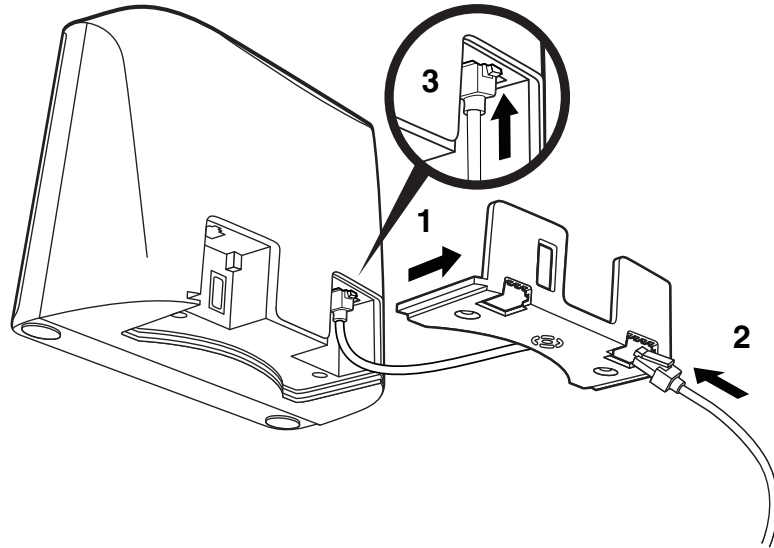

2. Slide the back cover on and screw the back cover to the device, and then connect the interface cable to the computer.

USB Connection:

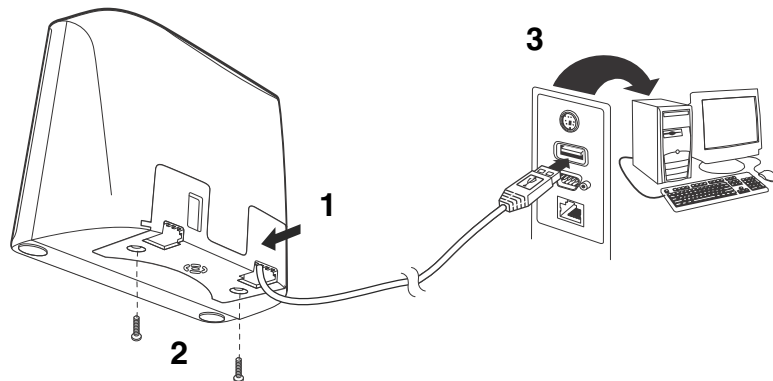

3. The scanner beeps.
4. Verify the scanner operation by scanning a bar code from the [Sample Symbols](#) on page 233.

The unit defaults to a USB PC Keyboard. Refer to [page 16](#) for other USB terminal settings.

For additional USB programming and technical information, refer to “USB Application Note,” available at the Knowledge Base www.hsm.force.com/publickb.

Connect with Keyboard Wedge

The scanner can be connected between the keyboard and PC as a “keyboard wedge,” where the scanner provides data output that is similar to keyboard entries. The following is an example of a keyboard wedge connection:

1. Turn off power and disconnect the keyboard cable from the back of the terminal/computer.
2. Remove the back cover and feed the interface cable through to the device.

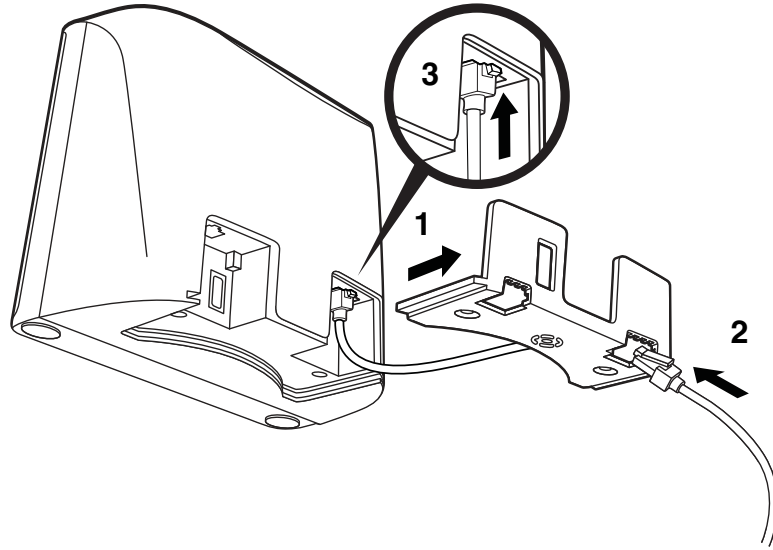

3. Feed the power supply cable through the back cover to the device. Make sure the power cable is completely inserted into the device.

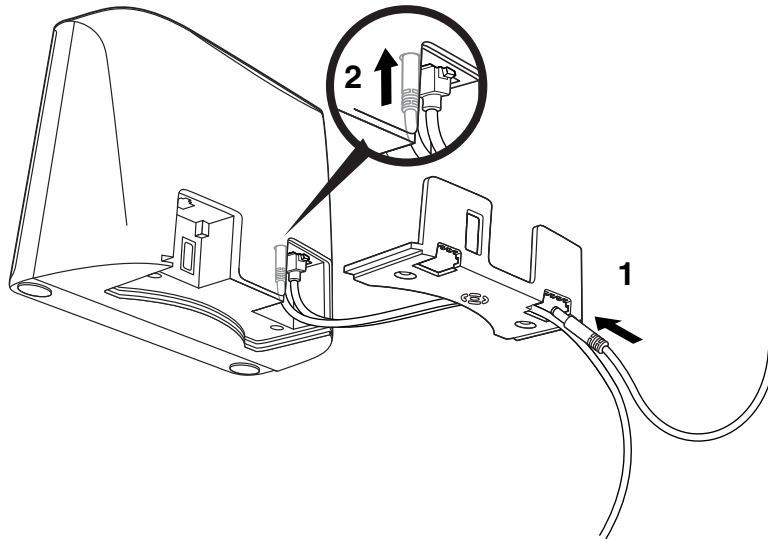

Note: The power supply must be ordered separately.

- Slide the back cover on and screw the back cover to the device. Connect the interface cable to the computer, and then plug the power supply into the outlet.

Keyboard Wedge Connection:

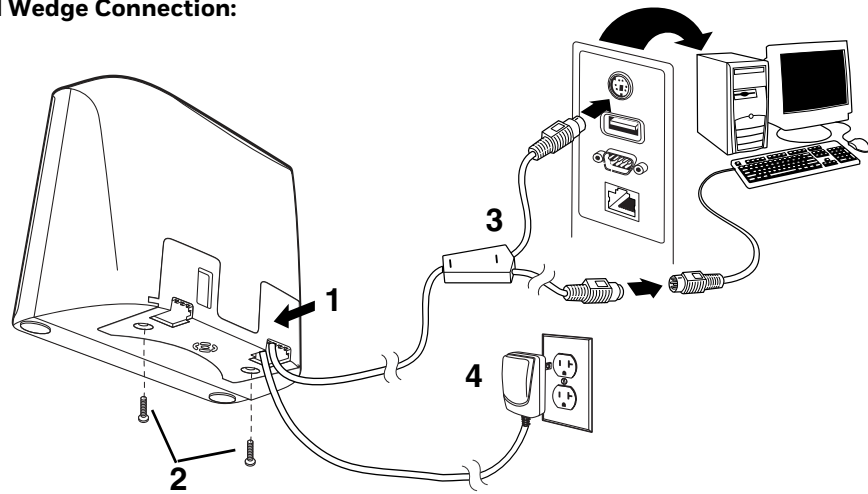

- Turn the terminal/computer power back on. The scanner beeps.
- Verify the scanner operation by scanning a bar code from the [Sample Symbols](#) on page 233. The scanner beeps once.

The unit defaults to an IBM PC AT and compatibles keyboard wedge interface with a USA keyboard. A carriage return (CR) suffix is added to bar code data.

Connect with RS232 Serial Port

1. Turn off power to the terminal/computer.
2. Remove the back cover and feed the interface cable through to the device.

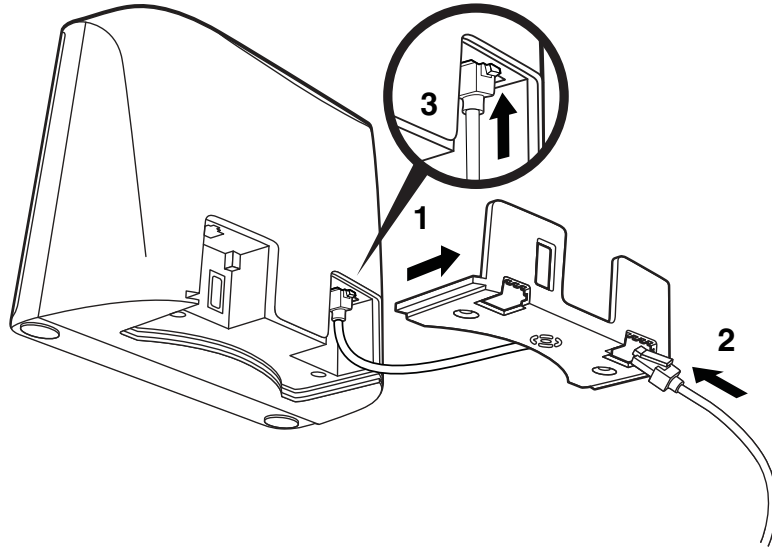

Note: For the scanner to work properly, you must have the correct cable for your type of terminal/computer.

3. Feed the power supply cable through the back cover to the device. Make sure the power cable is completely inserted into the device.

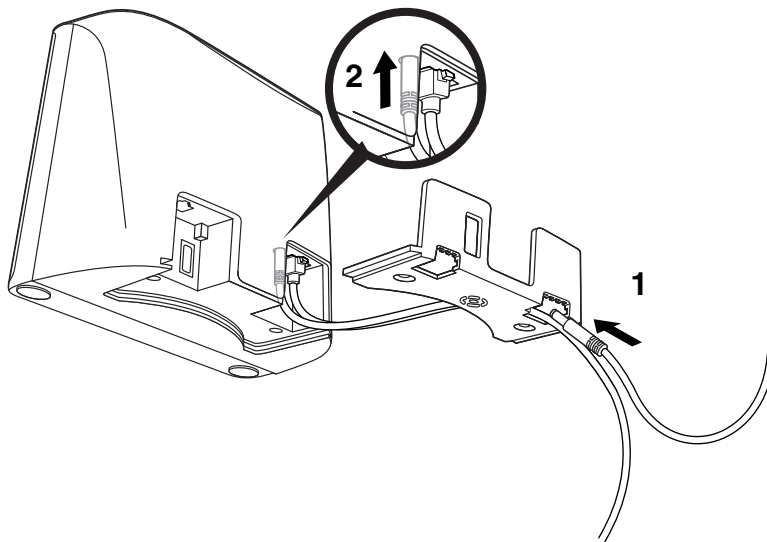

Note: The power supply must be ordered separately.

- Slide the back cover on and screw the back cover to the device. Connect the interface cable to the computer and tighten the two screws to secure the connector to the port. Plug the power supply into the outlet.

RS232 Serial Port Connection:

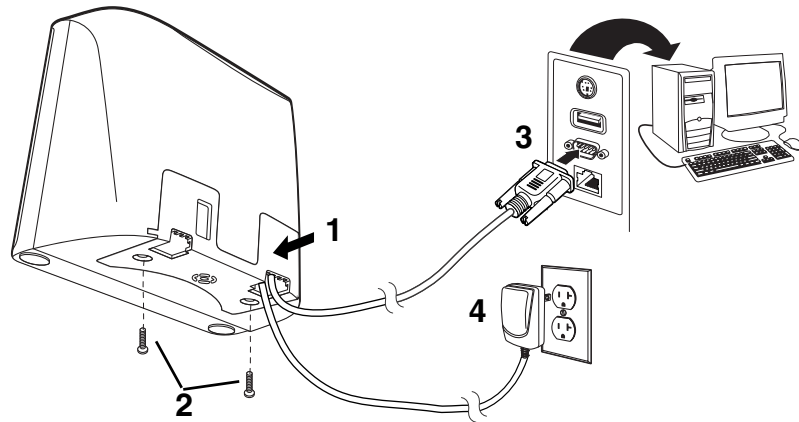

- Once the scanner has been fully connected, power up the computer. This interface programs 115,200 baud, 8 data bits, no parity, and 1 stop bit.

Connect with RS485

The scanner can be connected for an IBM POS terminal interface.

1. Remove the back cover and feed the interface cable through to the device.

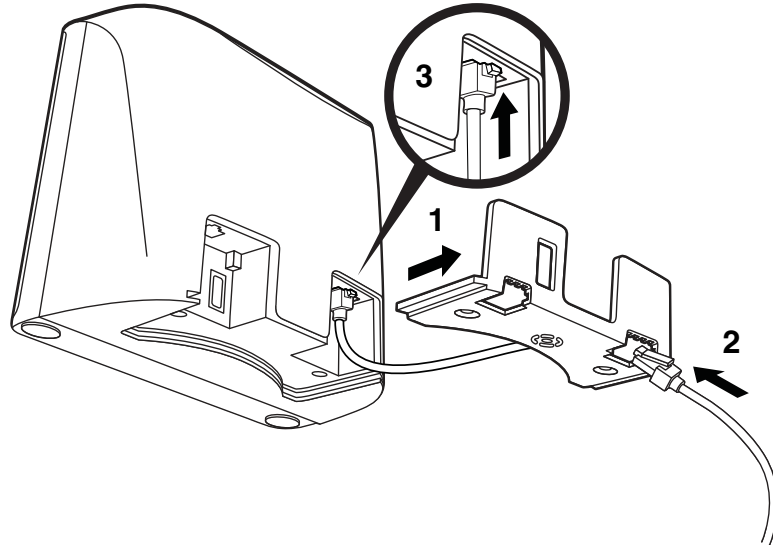

2. Slide the back cover on and screw the back cover to the device, and then connect the interface cable to the computer.

RS485 Connection:

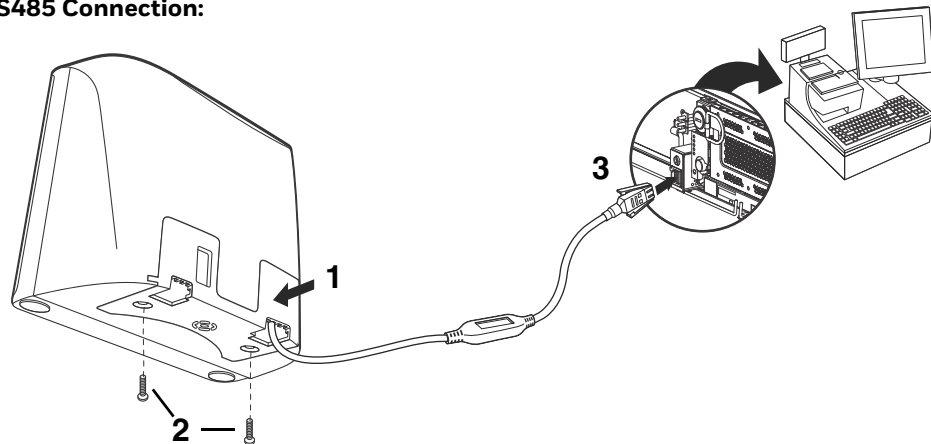

3. Turn the terminal/computer power back on. The scanner beeps.
4. Verify the scanner operation by scanning a bar code from the [Sample Symbols](#) on page 233. The scanner beeps once.

For further RS485 settings, refer to [RS485](#), page 14.

Connect EAS

Note: The 7980GEL does not support the EAS interface.

Checkpoint®

When connecting to a Checkpoint EAS system, connect the Checkpoint EAS cable to the EAS port on the left side of the scanner. Refer to [EAS Settings](#) beginning on page 151 for configuration codes and further EAS programming information.

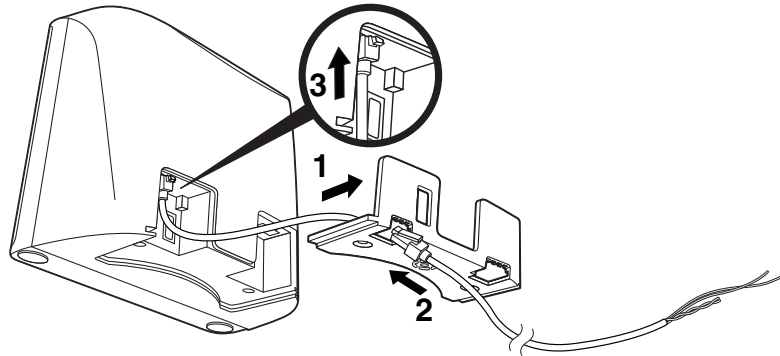

Sensormatic®

When connecting to a Sensormatic EAS system, connect the Sensormatic EAS cable to the EAS port on the left side of the scanner. Contact Tyco for further information about Sensormatic installation and configuration. Refer to [EAS Settings](#) beginning on page 151 for configuration codes and further EAS programming information.

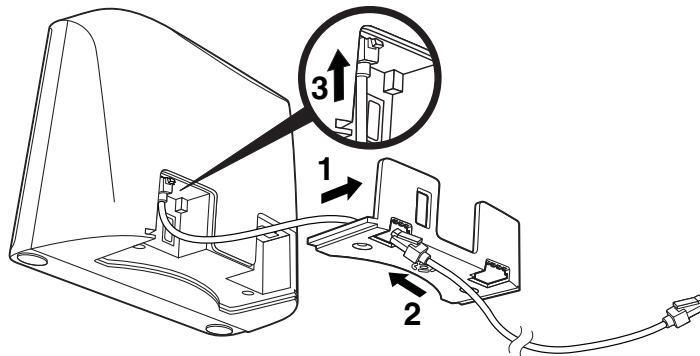

Connect Auxiliary Scanner

Note: *The 7980GEL does not support an Auxiliary Scanner.*

1. Connect the interface cable. See [Connect the Device](#) on page 1 for further information.
2. Remove the back cover and feed the power supply cable through to the device. Make sure the power cable is completely inserted into the device.

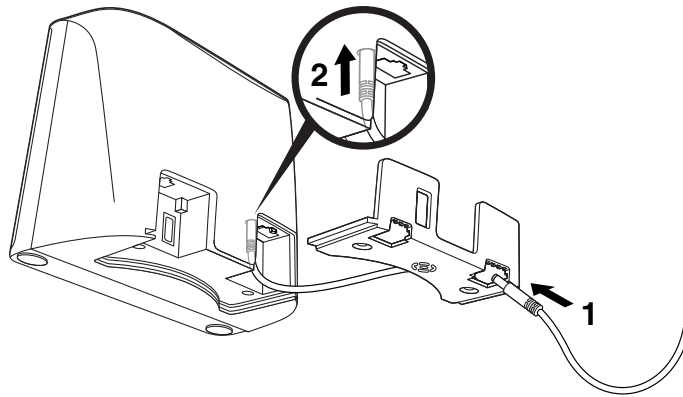

3. Slide the back cover on and screw the back cover to the device. Plug the power supply into the outlet

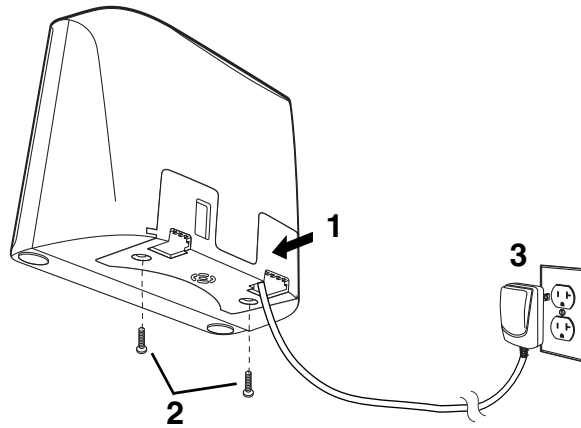

4. Connect the USB cable to the USB port on the left side of the scanner, and then connect the interface cable to the auxiliary scanner.

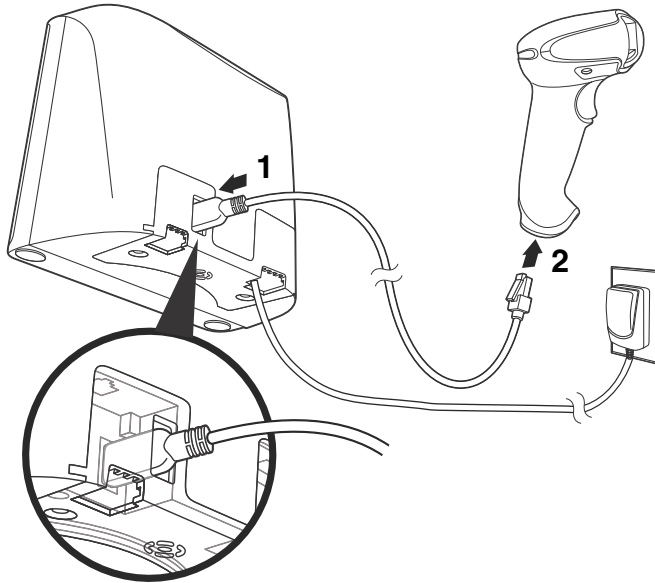

Button Functionality

Note: The 7980GEL does not support Button Functionality.

There are two buttons on the front of the device. The following is a brief description of the settings for the buttons.

Beeper Volume



Beeper Frequency

Beeper Volume Adjustment

When Volume Adjustment is set to **On**, pressing the Sound button repeatedly scrolls through the volume settings for the scanner's beeper. When set to **Off**, the Sound button does not scroll through these settings. *Default = Volume Adjustment On.*



BTNVOL0.

Volume Adjustment Off



BTNVOL1.

* Volume Adjustment On

Beeper Frequency Adjustment

When Frequency Adjustment is set to **On**, holding the Sound button down for up to 3 seconds scrolls through the frequency (tone) settings for the scanner's beeper. When set to **Off**, the Sound button does not scroll through these settings. *Default = Frequency Adjustment On.*



Frequency Adjustment Off



* Frequency Adjustment On

Reading Techniques

Present the bar code to the scanner. The LEDs turn up to read the code. If the light level in the room is not high enough, the code may not be read.

Menu Bar Code Security Settings

Honeywell scanners are programmed by scanning menu bar codes or by sending serial commands to the scanner. If you want to restrict the ability to scan menu codes, you can use the Menu Bar Code Security settings. Please contact the nearest technical support office (see [Technical Assistance](#) on page xi) for further information.

Set Custom Defaults

You have the ability to create a set of menu commands as your own, custom defaults. To do so, scan the **Set Custom Defaults** bar code below before scanning the menu commands for your custom defaults. If a menu command requires scanning numeric codes from the [Programming Chart](#), then a **Save** code, that entire

sequence will be saved to your custom defaults. When you have entered all the commands you want to save for your custom defaults, scan the **Save Custom Defaults** bar code.



You may have a series of custom settings and want to correct a single setting. To do so, just scan the new setting to overwrite the old one. For example, if you had previously saved the setting for Beeper Volume at Low to your custom defaults, and decide you want the beeper volume set to High, just scan the **Set Custom Defaults** bar code, then scan the **Beeper Volume High** menu code, and then **Save Custom Defaults**. The rest of the custom defaults will remain, but the beeper volume setting will be updated.

Reset the Custom Defaults

If you want the custom default settings restored to your scanner, scan the **Activate Custom Defaults** bar code below. This is the recommended default bar code for most users. It resets the scanner to the custom default settings. If there are no custom defaults, it will reset the scanner to the factory default settings. Any settings that have not been specified through the custom defaults will be defaulted to the factory default settings.



Introduction

This chapter describes how to program your system for the desired interface.

Program the Interface - Plug and Play

Plug and Play bar codes provide instant scanner set up for commonly used interfaces.

Note: After you scan one of the codes, power cycle the host terminal to have the interface in effect.

Keyboard Wedge

If you want your system programmed for an IBM PC AT and compatibles keyboard wedge interface with a USA keyboard, scan the bar code below. Keyboard wedge is the default interface.

Note: The following bar code also programs a carriage return (CR) suffix.



PAP_AT.

IBM PC AT and Compatibles with
CR suffix

Laptop Direct Connect

For most laptops, scanning the **Laptop Direct Connect** bar code allows operation of the scanner in parallel with the integral keyboard. The following **Laptop Direct Connect** bar code also programs a carriage return (CR) suffix and turns on Emulate External Keyboard ([page 28](#)).



RS232 Serial Port

The RS232 Interface bar code is used when connecting to the serial port of a PC or terminal. The following **RS232 Interface** bar code also programs a carriage return (CR) and a line feed (LF) suffix, baud rate, and data format as indicated below. It also changes the trigger mode to manual.

Option	Setting
Baud Rate	115,200 bps
Data Format	8 data bits, no parity bit, 1 stop bit



RS485

Scan one of the following “Plug and Play” codes to program the scanner for an IBM POS terminal interface.

Note: After scanning one of these codes, you must power cycle the cash register.





PAPP5B.

IBM Port 5B Interface



PAP9B2.

**IBM Port 9B
HHBCR-2 Interface**

Each bar code above also programs the following suffixes for each symbology:

Symbology	Suffix	Symbology	Suffix
EAN 8	0C	Code 39	00 0A 0B
EAN 13	16	Interleaved 2 of 5	00 0D 0B
UPC A	0D	Code 128 *	00 0A 0B
UPC E	0A	Code 128 **	00 18 0B
		Aztec	00 34 0B
		PDF417	00 2E 0B
		Data Matrix	00 32 0B
		QR	00 33 0B

* Suffixes programmed for Code 128 with IBM 4683 Port 5B, IBM 4683 Port 9B HHBCR-1, and IBM 4683 Port 17 Interfaces

** Suffixes programmed for Code 128 with IBM 4683 Port 9 HHBCR-2 Interface

RS485 Packet Mode

The following selection allows you to break up large bar code data into smaller packets on an IBM POS terminal. To break up large bar codes into small packets, scan the **Packet Mode On** bar code below. Scan the **Packet Mode Off** bar code if you want large bar code data to be sent to the host in a single chunk. *Default = Packet Mode Off.*



RTLPDF0.

*** Packet Mode Off**



RTLPDF1.

Packet Mode On

RS485 Packet Length

If you are using Packet mode, you can specify the size of the data “packet” that is sent to the host. Scan the **Packet Length** bar code, then the packet size (from 20 - 256) from the [Programming Chart](#), then **Save**. *Default = 40.*



USB IBM SurePos

Scan one of the following “Plug and Play” codes to program the scanner for an IBM SurePos (USB handheld scanner) or IBM SurePos (USB tabletop scanner) interface.

Note: *After scanning one of these codes, you must power cycle the cash register.*



Each bar code above also programs the following suffixes for each symbology:

Symbology	Suffix	Symbology	Suffix
EAN 8	0C	Code 39	00 0A 0B
EAN 13	16	Interleaved 2 of 5	00 0D 0B
UPC A	0D	Code 128	00 18 0B
UPC E	0A	Code 39	00 0A 0B

USB PC or Macintosh Keyboard

Scan one of the following codes to program the scanner for USB PC Keyboard or USB Macintosh Keyboard. Scanning these codes also adds a CR suffix.





TRMUSB134.
USB Japanese Keyboard (PC)



PAP125.
USB Keyboard (Mac)

USB HID

Scan the following code to program the scanner for USB HID bar code scanners.



PAP131.
USB HID Bar Code Scanner

USB Serial

Scan the following code to program the scanner to emulate a regular RS232-based COM Port. If you are using a Microsoft® Windows® PC, you will need to download a driver from the Honeywell website (www.honeywellaidc.com). The driver will use the next available COM Port number. Apple® Macintosh computers recognize the scanner as a USB CDC class device and automatically use a class driver.



TRMUSB130.
USB Serial

Note: No extra configuration (e.g., baud rate) is necessary.

CTS/RTS Emulation



USBCTS1.
CTS/RTS Emulation On



USBCTS0.
* CTS/RTS Emulation Off

ACK/NAK Mode



Verifone[®] Ruby Terminal Default Settings

Scan the following Plug and Play code to program the scanner for a Verifone Ruby terminal. This bar code sets the baud rate to 1200 bps and the data format to 8 data bits, no parity bit, 1 stop bit. It also adds a line feed (LF) suffix and programs the following prefixes for each symbology:

Symbology	Prefix
UPC-A	A
UPC-E	A
EAN-8	FF
EAN-13	F



Gilbarco[®] Terminal Default Settings

Scan the following Plug and Play code to program the scanner for a Gilbarco terminal. This bar code sets the baud rate to 2400 bps and the data format to 7 data bits, even parity, 2 stop bits. It adds a carriage return (CR) suffix and programs the following prefixes for each symbology:

Symbology	Prefix
UPC-A	A
UPC-E	E0
EAN-8	FF
EAN-13	F



Wincor Nixdorf Terminal Default Settings

Scan the following Plug and Play code to program the scanner for a Wincor Nixdorf terminal. This bar code sets the baud rate to 9600 bps and the data format to 8 data bits, no parity, 1 stop bit.



Wincor Nixdorf Beetle™ Terminal Default Settings

Scan the following Plug and Play code to program the scanner for a Wincor Nixdorf Beetle terminal. The following prefixes are programmed for each symbology:

Symbology	Prefix	Symbology	Prefix
Code 128	K	EAN-13	A
Code 93	L	GS1-128	P
Codabar	N	Interleaved 2 of 5	I
UPC-A	A0	Plessey	O
UPC-E	C	Straight 2 of 5 IATA	H
EAN-8	B	All other bar codes	M



Wincor Nixdorf RS232 Mode A

Scan the following Plug and Play code to program the scanner for a Wincor Nixdorf RS232 Mode A terminal. This bar code sets the baud rate to 9600 bps and the data format to 8 data bits, odd parity, 1 stop bit. The following prefixes are programmed for each symbology:

Symbology	Prefix	Symbology	Prefix
Code 128	K	EAN-13	A
Code 93	L	GS1-128	K
Codabar	N	Interleaved 2 of 5	I
UPC-A	A0	Plessey	O
UPC-E	C	Straight 2 of 5 IATA	H
EAN-8	B	GS1 DataBar	E
All other bar codes	M		



PAPWMA.

**Wincor Nixdorf RS232 Mode A
Settings**

Keyboard Country Layout

If your interface is USB Keyboard or Keyboard Wedge, your device default layout is a US keyboard. To change this layout, scan the appropriate Keyboard Country bar code below. By default, national character replacements are used for the following characters: # \$ @ [\] ^ ' { | } ~. Refer to the [ISO 2022/ISO 646 Character Replacements](#) on page 228 to view the character replacements for each country.

Keyboard Countries



KBDCTY0.
*** United States**



KBDCTY35.
Albania



KBDCTY81.
Azeri (Cyrillic)



KBDCTY80.
Azeri (Latin)



KBDCTY82.
Belarus



KBDCTY1.
Belgium



KBDCTY33.
Bosnia



KBDCTY16.
Brazil

Keyboard Countries (Continued)



KBDCTY59.
Brazil (MS)



KBDCTY53.
Bulgaria (Latin)



KBDCTY18.
Canada (French)



KBDCTY32.
Croatia



KBDCTY40.
Czech (Programmers)



KBDCTY38.
Czech (QWERTZ)



KBDCTY52.
Bulgaria (Cyrillic)



KBDCTY54.
Canada (French legacy)



KBDCTY55.
Canada (Multilingual)



KBDCTY15.
Czech



KBDCTY39.
Czech (QWERTY)



KBDCTY8.
Denmark

Keyboard Countries (Continued)



KBDCTY11.
Dutch (Netherlands)



KBDCTY83.
Faroese



KBDCTY3.
France



KBDCTY4.
Germany



KBDCTY64.
Greek (220 Latin)



KBDCTY65.
Greek (319 Latin)



KBDCTY41.
Estonia



KBDCTY2.
Finland



KBDCTY84.
Gaelic



KBDCTY17.
Greek



KBDCTY61.
Greek (220)



KBDCTY62.
Greek (319)

Keyboard Countries (Continued)



KBDCTY63.
Greek (Latin)



KBDCTY60.
Greek (Polytonic)



KBDCTY50.
Hungarian (101 key)



KBDCTY75.
Iceland



KBDCTY56.
Italian (142)



KBDCTY28.
Japan ASCII



KBDCTY66.
Greek (MS)



KBDCTY12.
Hebrew



KBDCTY19.
Hungary



KBDCTY73.
Irish



KBDCTY5.
Italy



KBDCTY78.
Kazakh

Keyboard Countries (Continued)



KBDCTY79.
Kyrgyz (Cyrillic)



KBDCTY42.
Latvia



KBDCTY44.
Lithuania



KBDCTY34.
Macedonia



KBDCTY86.
Mongolian (Cyrillic)



KBDCTY20.
Poland



KBDCTY14.
Latin America



KBDCTY43.
Latvia (QWERTY)



KBDCTY45.
Lithuania (IBM)



KBDCTY74.
Malta



KBDCTY9.
Norway



KBDCTY57.
Polish (214)

Keyboard Countries (Continued)



KBDCTY58.
Polish (Programmers)



KBDCTY25.
Romania



KBDCTY67.
Russian (MS)



KBDCTY21.
SCS



KBDCTY36.
Serbia (Latin)



KBDCTY49.
Slovakia (QWERTY)



KBDCTY13.
Portugal



KBDCTY26.
Russia



KBDCTY68.
Russian (Typewriter)



KBDCTY37.
Serbia (Cyrillic)



KBDCTY22.
Slovakia



KBDCTY48.
Slovakia (QWERTZ)

Keyboard Countries (Continued)



KBDCTY31.
Slovenia



KBDCTY51.
Spanish variation



KBDCTY29.
Switzerland (French)



KBDCTY85.
Tatar



KBDCTY24.
Turkey Q



KBDCTY7.
United Kingdom



KBDCTY10.
Spain



KBDCTY23.
Sweden



KBDCTY6.
Switzerland (German)



KBDCTY27.
Turkey F



KBDCTY76.
Ukrainian



KBDCTY87.
United States (Dvorak)

Keyboard Countries (Continued)



KBDCTY88.

United States (Dvorak left)



KBDCTY89.

United States (Dvorak)



KBDCTY30.

United States (International)



KBDCTY77.

Uzbek (Cyrillic)

Keyboard Style

This programs keyboard styles, such as Caps Lock and Shift Lock. If you have used [Keyboard Conversion](#) settings, they will override any of the following Keyboard Style settings. *Default = Regular.*

Regular is used when you normally have the Caps Lock key off.



KBDSTY0.

*** Regular**

Caps Lock is used when you normally have the Caps Lock key on.



KBDSTY1.

Caps Lock

Shift Lock is used when you normally have the Shift Lock key on (not common to U.S. keyboards).



KBDSTY2.

Shift Lock

Automatic Caps Lock is used if you change the Caps Lock key on and off. The software tracks and reflects if you have Caps Lock on or off. This selection can only be used with systems that have an LED that notes the Caps Lock status (AT keyboards).



Autocaps via NumLock bar code should be scanned in countries (e.g., Germany, France) where the Caps Lock key cannot be used to toggle Caps Lock. The NumLock option works similarly to the regular Autocaps, but uses the NumLock key to retrieve the current state of the Caps Lock.



Emulate External Keyboard should be scanned if you do not have an external keyboard (IBM AT or equivalent).



Note: After scanning the *Emulate External Keyboard* bar code, you must power cycle your computer.

Keyboard Conversion

Alphabetic keyboard characters can be forced to be all upper case or all lowercase. So if you have the following bar code: “abc569GK,” you can make the output “ABC569GK” by scanning **Convert All Characters to Upper Case**, or to “abc569gk” by scanning **Convert All Characters to Lower Case**.

These settings override [Keyboard Style](#) selections.

Note: If your interface is a keyboard wedge, first scan the menu code for [Automatic Caps Lock](#) (page 28). Otherwise, your output may not be as expected.

Default = Keyboard Conversion Off.





KBDENV1.

**Convert All Characters
to Upper Case**



KBDENV2.

**Convert All Characters
to Lower Case**

Control Character Output

This selection sends a text string instead of a control character. For example, when the control character for a carriage return is expected, the output would display [CR] instead of the ASCII code of 0D. Refer to [ASCII Conversion Chart \(Code Page 1252\)](#) on page 224. Only codes 00 through 1F are converted (the first column of the chart). *Default = Off.*

Note: *Control + X (Control + ASCII) Mode overrides this mode.*



KBDNPE1.

Control Character Output On



KBDNPE0.

*** Control Character Output Off**

Keyboard Modifiers

This modifies special keyboard features, such as CTRL+ ASCII codes and Turbo Mode.

Control + X (Control + ASCII) Mode On: The scanner sends key combinations for ASCII control characters for values 00-1F. Windows is the preferred mode. All keyboard country codes are supported. DOS mode is a legacy mode, and it does not support all keyboard country codes. New users should use the Windows mode. Refer to [ASCII Conversion Chart \(Code Page 1252\)](#), page 224 for CTRL+ X Values.

Windows Mode Prefix/Suffix Off: The scanner sends key combinations for ASCII control characters for values 00-1F, but it does not translate prefix or suffix information.

Default = Control + X Mode Off.



KBDCAS2.
**Windows Mode Control + X
 Mode On**



KBDCAS0.
*** Control + X Mode Off**



KBDCAS1.
DOS Mode Control + X Mode On



KBDCAS3.
Windows Mode Prefix/Suffix

Turbo Mode: The scanner sends characters to a terminal faster. If the terminal drops characters, do not use Turbo Mode. *Default = Off.*



KBDTMD1.
Turbo Mode On



KBDTMD0.
*** Turbo Mode Off**

Numeric Keypad Mode: Sends numeric characters as if entered from a numeric keypad. *Default = Off.*



KBDNPS1.
Numeric Keypad Mode On



KBDNPS0.
*** Numeric Keypad Mode Off**

Automatic Direct Connect Mode: This selection can be used if you have an IBM AT style terminal and the system is dropping characters. *Default = Off.*



KBDADC1.
**Automatic Direct Connect
 Mode On**



RS232 Modifiers

RS232 Baud Rate

Baud Rate sends the data from the scanner to the terminal at the specified rate. The host terminal must be set for the same baud rate as the scanner. *Default = 115,200.*





RS232 Word Length: Data Bits, Stop Bits, and Parity

Data Bits sets the word length at 7 or 8 bits of data per character. If an application requires only ASCII Hex characters 0 through 7F decimal (text, digits, and punctuation), select 7 data bits. For applications that require use of the full ASCII set, select 8 data bits per character. *Default = 8.*

Stop Bits sets the stop bits at 1 or 2. *Default = 1.*

Parity provides a means of checking character bit patterns for validity. *Default = None.*





RS232 Receiver Time-Out

The unit stays awake to receive data until the RS232 Receiver Time-Out expires. A manual or serial trigger resets the time-out. When an RS232 receiver is sleeping, a character may be sent to wake up the receiver and reset the time-out. A transaction on the CTS line will also wake up the receiver. The receiver takes 300 milliseconds to completely come up. Change the RS232 receiver time-out by scanning the bar code below, then scanning digits from the [Programming Chart](#), then scanning **Save**. The range is 0 to 300 seconds. *Default = 0 seconds (no time-out - always on).*



RS232 Handshaking

RS232 Handshaking allows control of data transmission from the scanner using software commands from the host device. When RTS/CTS is turned Off, no data flow control is used.

Flow Control, No Timeout: The scanner asserts RTS when it has data to send, and will wait indefinitely for CTS to be asserted by the host.

Two-Direction Flow Control: The scanner asserts RTS when it is OK for the host to transmit. The host asserts CTS when it is OK for the device to transmit.

Flow Control with Timeout: The scanner asserts RTS when it has data to send and waits for a delay (see [RS232 Timeout](#) on page 34) for CTS to be asserted by the host. If the delay time expires and CTS is not asserted, the device transmit buffer is cleared and scanning may resume.

Default = RTS/CTS Off.





RS232 Timeout

When using **Flow Control with Timeout**, you must program the length of the delay you want to wait for CTS from the host. Set the length (in milliseconds) for a timeout by scanning the bar code below, then setting the timeout (from 1-5100 milliseconds) by scanning digits from the [Programming Chart](#), then scanning **Save**.



XON/XOFF

Standard ASCII control characters can be used to tell the scanner to start sending data (XON/XOFF On) or to stop sending data (XON/XOFF Off). When the host sends the XOFF character (DC3, hex 13) to the scanner, data transmission stops. To resume transmission, the host sends the XON character (DC1, hex 11). Data transmission continues where it left off when XOFF was sent. *Default = XON/XOFF Off.*



ACK/NAK

After transmitting data, the scanner waits for an ACK character (hex 06) or a NAK character (hex 15) response from the host. If ACK is received, the communications cycle is completed and the scanner looks for more bar codes. If NAK is received, the

last set of bar code data is retransmitted and the scanner waits for ACK/NAK again. Turn on the ACK/NAK protocol by scanning the ACK/NAK On bar code below. To turn off the protocol, scan ACK/NAK Off. *Default = ACK/NAK Off.*



232ACK1.
ACK/NAK On



232ACK0.
*** ACK/NAK Off**

Power Up Beeper

The scanner can be programmed to beep when it's powered up. Scan the **Off** bar code(s) if you don't want a power up beep. *Default = Power Up Beeper On.*



BEPPWR0.

Power Up Beeper Off



BEPPWR1.

*** Power Up Beeper On**

Beep on BEL Character

You may wish to force the scanner to beep upon a command sent from the host. If you scan the **Beep on BEL On** bar code below, the scanner will beep every time a BEL character is received from the host. *Default = Beep on BEL Off.*



BELBEP0.

***Beep on BEL Off**



BELBEP1.

Beep on BEL On

Good Read and Error Indicators

Beeper – Good Read

The beeper may be programmed **On** or **Off** in response to a good read. Turning this option off only turns off the beeper response to a good read indication. All error and menu beeps are still audible. *Default = Beeper - Good Read On.*



BEPBEP0.

Beeper - Good Read Off



BEPBEP1.

*** Beeper - Good Read On**

Beeper Volume – Good Read

The beeper volume codes modify the volume of the beep the scanner emits on a good read. *Default = High.*



BEPLVL1.

Low



BEPLVL2.

Medium



BEPLVL3.

*** High**



BEPLVL0.

Off

Beeper Pitch – Good Read

The beeper pitch codes modify the pitch (frequency) of the beep the scanner emits on a good read. *Default = Low.*



BEPFQ1870.

* Low (870 Hz)



BEPFQ11140.

Medium (1140 Hz)



BEPRQ11800.

High (1800 Hz)

Beeper Pitch – Error

The beeper pitch codes modify the pitch (frequency) of the sound the scanner emits when there is a bad read or error. *Default = Razz.*



BEPFQ2250.

* Razz (250 Hz)



BEPFQ23250.

Medium (3250 Hz)



BEPFQ24200.

High (4200 Hz)

Beeper Duration – Good Read

The beeper duration codes modify the length of the beep the scanner emits on a good read. *Default = Normal.*



BEPBIP0.

* Normal Beep



BEPBIP1.

Short Beep

LED – Good Read

The LED indicator can be programmed **On** or **Off** in response to a good read.
Default = On.



BEPLED1.

* LED - Good Read On



BEPLED0.

LED - Good Read Off

Number of Beeps – Good Read

The number of beeps of a good read can be programmed from 1 - 9. The same number of beeps will be applied to the beeper and LED in response to a good read. For example, if you program this option to have five beeps, there will be five beeps and five LED flashes in response to a good read. The beeps and LED flashes are in sync with one another. To change the number of beeps, scan the bar code below and then scan a digit (1-9) bar code and the **Save** bar code on the [Programming Chart](#). *Default = 1.*



BEPRPT.

Number of Good Read Beeps/LED Flashes

Number of Beeps – Error

The number of beeps and LED flashes emitted by the scanner for a bad read or error can be programmed from 1 - 9. For example, if you program this option to have five error beeps, there will be five error beeps and five LED flashes in response to an error. To change the number of error beeps, scan the bar code below and then scan a digit (1-9) bar code and the **Save** bar code on the [Programming Chart](#). *Default = 5.*



BEPERR.

Number of Error Beeps/LED Flashes

Good Read Delay

This sets the minimum amount of time before the scanner can read another bar code. *Default = 0 ms (No Delay).*



DLYGRD0.

* No Delay



DLYGRD500.

Short Delay (500 ms)



DLYGRD1000.

Medium Delay (1,000 ms)



DLYGRD1500.

Long Delay (1,500 ms)

User-Specified Good Read Delay

If you want to set your own length for the good read delay, scan the bar code below, then set the delay (from 0 - 30,000 milliseconds) by scanning digits from the [Programming Chart](#), then scanning **Save**.



DLYGRD.

User-Specified Good Read Delay

Serial Trigger Mode

You can activate the scanner by using a serial trigger command (see [Trigger Commands](#) on page 186). When in serial mode, the scanner scans until a bar code has been read or until the deactivate command is sent. The scanner can also be set to turn itself off after a specified time has elapsed (see [Read Time-Out](#), which follows).

Read Time-Out

Use this selection to set a time-out (in milliseconds) of the scanner's trigger when using serial commands to trigger the scanner. Once the scanner has timed out, you can activate the scanner either by pressing the trigger or using a serial trigger

command. After scanning the **Read Time-Out** bar code, set the time-out duration (from 0-300,000 milliseconds) by scanning digits on the [Programming Chart](#), then scanning **Save**. *Default = 30,000 ms.*



Presentation Mode

Presentation Mode uses ambient light and scanner illumination to detect bar codes. When in Presentation Mode, the LEDs remain dim until a bar code is presented to the scanner, then the LEDs turn up to read the code. Scan the following bar code to program your device for Presentation Mode. *Default = Presentation Mode.*



Presentation Idle Mode

When **Presentation Idle Mode** is selected, the scanner goes into idle mode (illumination dims) after the time interval set, during which there is no activity. Change the Presentation Idle mode by scanning the bar code below, and then scanning digits from the [Programming Chart](#), then scanning **Save**. The range is 0 to 3000000. The scanner will wake when an object is presented to the window or the pitch or volume button is pressed. *Default = 10000 (10s).*

When **Off** is selected, no power saving is used and the scanner remains powered on.

Note: *In some conditions the scanner will switch between [Presentation Idle Mode](#) and [Presentation Sleep Mode](#) according to ambient light level. This allows the scanner to wake up in very dark conditions.*

Note: *This selection is unavailable when the [Illumination Lights](#) or [LED Illumination - Presentation Mode](#) are set to off.*



Presentation Sleep Mode

When **Presentation Sleep Mode On** is selected, the scanner goes into sleep mode (illumination is off and the LED will slowly blink on and off) after the time interval set using [Presentation Sleep Mode Timeout](#), during which there is not activity. The scanner will wake when an object is presented to the window or the pitch or volume button is pressed. *Default = Presentation Sleep Mode On.*

Note: *In some conditions the scanner will switch between [Presentation Idle Mode](#) and [Presentation Sleep Mode](#) according to ambient light level. This allows the scanner to wake up in very dark conditions.*

Note: *This selection is unavailable when the [Illumination Lights](#) or [LED Illumination - Presentation Mode](#) are set to off.*



TRGTSI1.

* On



TRGTSI0.

Off

Presentation Sleep Mode Timeout

Use this selection to set a timeout (in seconds) for the scanner when using [Presentation Sleep Mode](#). When this time has elapsed with no activity, the scanner will enter the Presentation Sleep Mode timeout selected. After scanning the **Pre-sentation Sleep Mode Timeout** bar code, set the timeout duration (from 0-3600000) by scanning digits on the [Programming Chart](#), then scanning [Save](#). *Default = 300000 (300s).*



TRGTST.

**Presentation Sleep Mode
Timeout**

LED Illumination - Presentation Mode

If you wish to set the illumination LED brightness, scan one of the bar codes below. This sets the LED illumination for the scanner when it is in Presentation Mode. (If the scanner is triggered manually, the LED illumination will switch to the setting for a manual trigger. See [Serial Trigger Mode](#) on page 41.) *Default = High.*

Note: *The LEDs are like a flash on a camera. The lower the ambient light in the room, the brighter the LEDs need to be so the scanner can “see” the bar codes.*

Note: *The LEDs may turn off for a short time when the scanner detects low power.*



PWRLDC0.
Off



PWRLDC100.
Low



PWRLDC150.
*** High**

Presentation LED Behavior after Decode

If you wish to dim the LEDs immediately after a bar code is decoded, scan the **LEDs Off** bar code, below. *Default = LEDs On.*



TRGPCK1.
*** LEDs On**



TRGPCK0.
LEDs Off

Presentation Sensitivity

Presentation Sensitivity is a numeric range that increases or decreases the scanner's reaction time to bar code presentation. To set the sensitivity, scan the **Sensitivity** bar code, then scan the degree of sensitivity (from 0-20) from the [Programming Chart](#), and scan **Save**. 0 is the most sensitive setting, and 20 is the least sensitive. *Default = 1.*



Presentation Centering

Use Presentation Centering to narrow the scanner's field of view when it is in Presentation Mode to make sure the scanner reads only those bar codes intended by the user. For instance, if multiple codes are placed closely together, Presentation Centering will insure that only the desired codes are read.

If a bar code is not touched by a predefined window, it will not be decoded or output by the scanner. If Presentation Centering is turned on by scanning **Presentation Centering On**, the scanner only reads codes that pass through the centering window you specify using the **Top of Presentation Centering Window**, **Bottom of Presentation Centering Window**, **Left**, and **Right of Presentation Centering Window** bar codes.

In the example below, the white box is the centering window. The centering window has been set to 20% left, 30% right, 8% top, and 25% bottom. Since Bar Code 1 passes through the centering window, it will be read. Bar Code 2 does not pass through the centering window, so it will not be read.

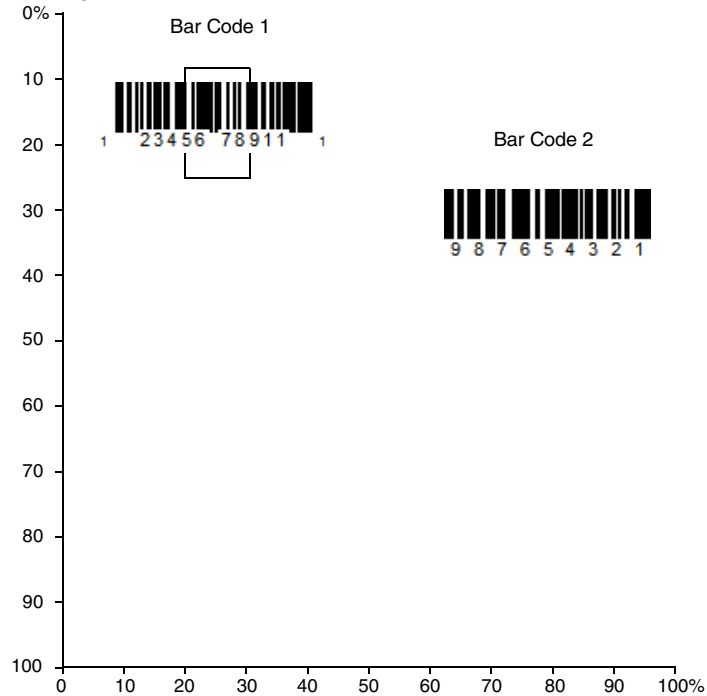

Note: A bar code needs only to be touched by the centering window in order to be read. It does not need to pass completely through the centering window.

Scan **Presentation Centering On**, then scan one of the following bar codes to change the top, bottom, left, or right of the centering window. Then scan the percent you want to shift the centering window using digits on the [Programming Chart](#). Scan **Save**. Default Presentation Centering = 40% for Top and Left, 60% for Bottom and Right.





PDCLFT.
Left of
Presentation Centering
Window



PDCBOT.
Bottom of Presentation
Centering Window



PDCRGT.
Right of Presentation
Centering Window

Streaming Presentation™ Mode

When in Streaming Presentation mode, the scan illumination remains on all the time to continuously search for bar codes. Two modes are available, Normal and Enhanced. Normal mode offers good scan speed and the longest working ranges (depth of field). Enhanced mode will give you the highest possible scan speed but slightly less range than Normal mode. Enhanced mode is best used when you require a very fast scan speed and don't require a long working range.



PAPSFN.
Streaming Presentation
Mode - Normal



PAPSPE.
Streaming Presentation
Mode - Enhanced

When using [Preferred Symbology](#) (page 3-51), a lower priority symbol must be centered on the aiming pattern to be read in Streaming Presentation Mode.

Mobile Phone Read Mode

When this mode is selected, your scanner is optimized to read bar codes from mobile phone or other LED displays. However, the speed of scanning printed bar codes may be slightly lower when this mode is enabled.



PAPPSC.
Presentation - Mobile Phone

Poor Quality PDF Codes

This setting improves the scanner's ability to read damaged or badly printed PDF codes by combining information from multiple images. When **Poor Quality PDF On** is scanned, poor quality PDF code reading is improved, but the scanner's snap-piness is decreased, making it less aggressive when reading good quality bar codes. This setting does not affect 1D bar code reading. *Default = Poor Quality PDF Reading Off.*



Poor Quality PDF Reading On



*** Poor Quality PDF Reading**

Poor Quality Code Enhanced Mode

If you are having a difficulty reading poor quality bar codes, you may wish to scan the **Poor Quality Code Enhanced Mode** bar code below to improve the read rate.



Poor Quality Code Enhanced Mode

Reread Delay

This sets the time period before the scanner can read the *same* bar code a second time. Setting a reread delay protects against accidental rereads of the same bar code. Longer delays are effective in minimizing accidental rereads. Use shorter delays in applications where repetitive bar code scanning is required. Reread Delay only works when in a [Presentation Mode](#) (see page 42). *Default = Short.*



*** Short (500 ms)**



Medium (750 ms)



DLYRRD1000.
Long (1000 ms)



DLYRRD2000.
Extra Long (2000 ms)

User-Specified Reread Delay

If you want to set your own length for the reread delay, scan the bar code below, then set the delay (from 0-30,000 milliseconds) by scanning digits from the [Programming Chart](#), then scanning **Save**.



DLYRRD.
User-Specified Reread Delay

Illumination Lights

If you want the illumination lights on while reading a bar code, scan the **Lights On** bar code, below. However, if you want to turn just the lights off, scan the **Lights Off** bar code. *Default = Lights On.*



SCNLED1.
* Lights On



SCNLED0.
Lights Off

Centering

Use Centering to narrow the scanner's field of view to make sure that when the scanner is hand-held, it reads only those bar codes intended by the user. For instance, if multiple codes are placed closely together, centering will insure that only the desired codes are read. (Centering can be used in conjunction with [Centering](#), page 49, for the most error-free operation in applications where multiple codes are spaced closely together.)

Note: To adjust centering when the scanner is in Presentation Mode, see [Presentation Centering](#) (page 3-45).

If a bar code is not touched by a predefined window, it will not be decoded or output by the scanner. If centering is turned on by scanning **Centering On**, the scanner only reads codes that pass through the centering window you specify using the **Top of Centering Window, Bottom of Centering Window, Left**, and **Right of Centering Window** bar codes.

In the example below, the white box is the centering window. The centering window has been set to 20% left, 30% right, 8% top, and 25% bottom. Since Bar Code 1 passes through the centering window, it will be read. Bar Code 2 does not pass through the centering window, so it will not be read.

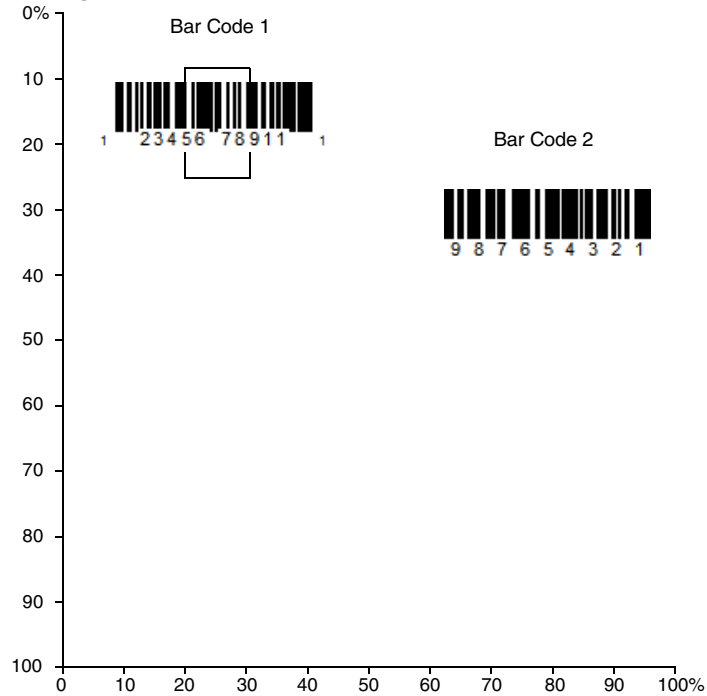

Note: A bar code needs only to be touched by the centering window in order to be read. It does not need to pass completely through the centering window.

Scan **Centering On**, then scan one of the following bar codes to change the top, bottom, left, or right of the centering window. Then scan the percent you want to shift the centering window using digits on the [Programming Chart](#). Scan **Save**. Default Centering = 40% for Top and Left, 60% for Bottom and Right.





DECTOP.

Top of Centering Window



DECBOT.

Bottom of Centering Window



DECLFT.

Left of Centering Window



DECRGT.

Right of Centering Window

Preferred Symbology

The scanner can be programmed to specify one symbology as a higher priority over other symbologies in situations where both bar code symbologies appear on the same label, but the lower priority symbology cannot be disabled.

For example, you may be using the scanner in a retail setting to read U.P.C. symbols, but have occasional need to read a code on a drivers license. Since some licenses have a Code 39 symbol as well as the PDF417 symbol, you can use Preferred Symbology to specify that the PDF417 symbol be read instead of the Code 39.

Preferred Symbology classifies each symbology as high priority, low priority, or as an unspecified type. When a low priority symbology is presented, the scanner ignores it for a set period of time (see [Preferred Symbology Time-out](#) on page 52) while it searches for the high priority symbology. If a high priority symbology is located during this period, then that data is read immediately.

If the time-out period expires before a high priority symbology is read, the scanner will read any bar code in its view (low priority or unspecified). If there is no bar code in the scanner's view after the time-out period expires, then no data is reported.

Note: *A low priority symbol must be centered on the aiming pattern to be read.*

Scan a bar code below to enable or disable Preferred Symbology. *Default = Preferred Symbology Off.*



PRFENA1.

Preferred Symbology On



PRFENAO.

* Preferred Symbology Off

High Priority Symbology

To specify the high priority symbology, scan the High Priority Symbology bar code below. On the [Symbology Charts](#), find the symbology you want to set as high priority. Locate the Hex value for that symbology and scan the 2 digit hex value from the [Programming Chart](#). Scan **Save** to save your selection. *Default = None*



PRFCOD.

High Priority Symbology

Low Priority Symbology

To specify the low priority symbology, scan the Low Priority Symbology bar code below. On the [Symbology Charts](#), find the symbology you want to set as low priority. Locate the Hex value for that symbology and scan the 2 digit hex value from the [Programming Chart](#).

If you want to set additional low priority symbologies, scan **FF**, then scan the 2 digit hex value from the [Programming Chart](#) for the next symbology. You can program up to 5 low priority symbologies. Scan **Save** to save your selection. *Default = None*



PRFBLK.

Low Priority Symbology

Preferred Symbology Time-out

Once you have enabled Preferred Symbology and entered the high and low priority symbologies, you must set the time-out period. This is the period of time the scanner will search for a high priority bar code after a low priority bar code has been encountered. Scan the bar code below, then set the delay (from 1-3,000 milliseconds) by scanning digits from the [Programming Chart](#), then scanning **Save**. *Default = 500 ms.*



PRFPTO.

Preferred Symbology Time-out

Preferred Symbology Default

Scan the bar code below to set all Preferred Symbology entries to their default values.



Character Activation Mode

You may use a character sent from the host to trigger the scanner to begin scanning. When the activation character is received, the scanner continues scanning until either the [Character Activation LED Timeout](#) (page 3-54) is reached, the deactivation character is received (see [Deactivation Character](#) on page 55), or a bar code is transmitted. Scan the **On** bar code to use character activation, then use [Activation Character](#) (page 3-53) to select the character you will send from the host to start scanning. *Default = Off.*



Activation Character

This sets the character used to trigger scanning when using Character Activation Mode. On the [ASCII Conversion Chart \(Code Page 1252\)](#), page 224, find the hex value that represents the character you want to use to trigger scanning. Scan the following bar code, then use the [Programming Chart](#) to read the alphanumeric combination that represents that ASCII character. Scan **Save** to finish.



End Character Activation After Good Read

After a bar code is successfully detected and read from the scanner, the LED can be programmed either to remain on and scanning, or to turn off. When **End Character Activation After Good Read** is enabled, the LED turns off and stops scanning after

a good read. If you scan **Do Not End Character Activation After Good Read**, the LED remains on after a good read. *Default = End Character Activation After Good Read.*



HSTCGD0.

**Do Not End Character
Activation After Good Read**



HSTCGD1.

*** End Character Activation
After Good Read**

Character Activation LED Timeout

You can set a timeout for the length of time the LED remains on and attempting to decode bar codes when using Character Activation Mode. Set the length (in milliseconds) for a timeout by scanning the following bar code, then setting the timeout (from 1-65535 milliseconds) by scanning digits from the [Programming Chart](#), then scanning **Save**. *Default = 5000 ms.*



HSTCDT.

**Character Activation LED
Timeout**

Character Deactivation Mode

If you have sent a character from the host to trigger the scanner to begin scanning, you can also send a deactivation character to stop scanning. Scan the following **On** bar code to use character deactivation, then use [Deactivation Character](#) to select the character you will send from the host to terminate scanning. *Default = Off.*



HSTDEN0.

*** Off**



HSTDEN1.

On

Deactivation Character

This sets the character used to terminate scanning when using Character Deactivation Mode. On the [ASCII Conversion Chart \(Code Page 1252\)](#), find the hex value that represents the character you want to use to terminate scanning. Scan the following bar code, then use the [Programming Chart](#) to read the alphanumeric combination that represents that ASCII character. Scan **Save** to finish.



Output Sequence Overview

Output Sequence Editor

This programming selection allows you to program the scanner to output data (when scanning more than one symbol) in whatever order your application requires, regardless of the order in which the bar codes are scanned. You can define up to 15 bar codes in an output sequence.

Note: To make Output Sequence Editor selections, you'll need to know the code I.D., code length, and character match(es) your application requires. Use the alphanumeric symbols from the [Programming Chart](#).

To Add an Output Sequence

An output sequence is created using a string of serial commands that is sent to the scanner. This string is most easily sent to the scanner using the EZConfig software tool (see [EZConfig Cloud for Scanning Introduction](#)). You can also accomplish this by scanning alphanumeric bar codes (see the [Programming Chart](#)).

1. If you are using bar codes to create your output sequence, scan [Enter Output Sequence](#) on page 59.
2. **Code I.D.**
On the [Symbology Charts](#), find the symbology to which you want to apply the output sequence format. Make a note of the hex value for that symbology. If you are using bar codes to create your output sequence, scan the 2 digit hex value from the [Programming Chart](#).
3. **Length**
Specify what length (up to 9999 characters) of data output will be acceptable for this symbology. Make a note of the length. If you are using bar codes to create your output sequence, scan the 4 digit data length [Programming Chart](#). (Note: 50 characters is entered as **0050**. 9999 is a universal number, indicating all lengths.) When calculating the length, you must count any programmed

prefixes, suffixes, or formatted characters as part of the length (unless using 9999).

4. **Character Match Sequences**

On the [ASCII Conversion Chart \(Code Page 1252\)](#), find the hex value that represents the character(s) you want to match. Make a note of the hex value for the character(s). If you are using bar codes to create your output sequence, use the [Programming Chart](#) to read the alphanumeric combination that represents the ASCII characters. (99 is the universal number, indicating all characters.)

5. **End Output Sequence Editor**

Use **FF** to terminate this string or to begin another output sequence. If you are using bar codes, scan **F F**. Scan **Save** to save your entries.

Other Programming Selections

If you are creating an output sequence using bar codes, scan [Discard](#) (page 236) to exit without saving any output sequence changes.

Output Sequence Editor Commands

SEQBLK	Sequence editor start command.
SEQPRE	Add prefix to complete output sequences.
SEQSUF	Add suffix to complete output sequences.
SEQSEP	Add separators to complete output sequences.
SEQTTS1	Transmit partial sequence.
SEQIPR	Add prefix to partial output sequences.
SEQISU	Add suffix to partial output sequences.
SEQISE	Add separators to partial output sequences.
TRGSTO	Timeout for partial output sequences.
FF	Termination string.

Examples outlining how to use these commands are shown below.

Output Sequence Example 1 - Three Symbologies



In this example, you are scanning PDF417, Code 128, and Code 39 bar codes, but you want the scanner to output Code 39 first, Code 128 second, and PDF417 third.

Set up the sequence editor with the following command line:

SEQBLK	sequence editor start command
62	code identifier for Code 39
9999	code length that must match for Code 39, 9999 = all lengths
43	start character match for Code 39, 43h = "C"
FF	termination string for first code
6A	code identifier for Code 128
9999	code length that must match for Code 128, 9999 = all lengths
54	start character match for Code 128, 54h = "T"
FF	termination string for first code
72	code identifier for PDF417
9999	code length that must match for PDF417, 9999 = all lengths
4D	start character match for PDF417, 4Dh = "M"
FF	termination string for third code

The whole command line would look like this:

SEQBLK62999943FF6A999954FF7299994DFF

The data is output as:

CODE39SMPLTSTMSGCODE128MSGPDF417

See the next example to further refine this output.

Output Sequence Example 2 - Three Symbologies with <> Separators

In this example, you are scanning the same three bar codes, but you want <> brackets and a carriage return and line feed to separate your output.



The sequence editor would use the same command line as shown in [Output Sequence Example 1 - Three Symbologies](#) (page 56):

SEQBLK	sequence editor start command
62	code identifier for Code 39
9999	code length that must match for Code 39, 9999 = all lengths
43	start character match for Code 39, 43h = "C"
FF	termination string for first code
6A	code identifier for Code 128
9999	code length that must match for Code 128, 9999 = all lengths
54	start character match for Code 128, 54h = "T"
FF	termination string for first code
72	code identifier for PDF417
9999	code length that must match for PDF417, 9999 = all lengths
4D	start character match for PDF417, 4Dh = "M"
FF	termination string for third code

But you would add your <> separators for each sequence:

SEQSEP99	separator for each sequence, 99 = all symbologies
3C	left bracket (<)
3E	right bracket (>)

And add the carriage return and line feed as a suffix:

SEQSUF99	separator for suffixes, 99 = all symbologies
0D	carriage return
0A	line feed

The whole command line would look like this:

```
SEQBLK62999943FF6A999954FF7299994DFFSEQSEP993C3ESEQSUF990D0A
```

The data is output as:

```
<CODE39SMPL>  
<TSTMSGCODE128>  
<MSGPDF417>
```

Enter Output Sequence

If you are using bar codes to create your output sequence, scan **Enter Output Sequence** to begin scanning your string.



SEQBLK.

Enter Output Sequence

Partial Sequence

If an output sequence operation is terminated before all your output sequence criteria are met, the bar code data acquired to that point is a “partial sequence.” You can define how partial sequences are output using the same types of command strings you used to create output sequences.

Partial Sequence Example - Three Symbolologies with <> Separators, but with a Damaged Code

In this example, you are scanning PDF417, Code 128, and Code 39 bar codes, and you want the scanner to output Code 39 first, Code 128 second, and PDF417 third, in brackets, as shown below, but the Code 39 bar code has been damaged and cannot be output.



You would use the same command line as shown in [Output Sequence Example 2 - Three Symbolologies with <> Separators](#) (page 57):

SEQBLK	sequence editor start command
62	code identifier for Code 39
9999	code length that must match for Code 39, 9999 = all lengths
43	start character match for Code 39, 43h = "C"
FF	termination string for first code
6A	code identifier for Code 128
9999	code length that must match for Code 128, 9999 = all lengths

54	start character match for Code 128, 54h = "T"
FF	termination string for first code
72	code identifier for PDF417
9999	code length that must match for PDF417, 9999 = all lengths
4D	start character match for PDF417, 4Dh = "M"
FF	termination string for third code
SEQSEP99	separator for each sequence, 99 = all symbologies
3C	left bracket (<)
3E	right bracket (>)
SEQSUF99	separator for suffixes, 99 = all symbologies
0D	carriage return
0A	line feed

And you would add **>PARTIAL<** as the prefix to note the partial sequence:

SEQTTS1	transmit partial sequence
SEQISU99	add partial sequence prefix, 99 = all symbologies
3E	right bracket (>)
50	P
41	A
52	R
54	T
49	I
41	A
4C	L
3C	left bracket (<)

The whole command line would look like this:

```
SEQBLK62999943FF6A999954FF7299994DFFSEQSEP993C3ESEQSUF990D0
ASEQTTS1SEQISU993E5041525449414C3C
```

The data is output as:

```
>PARTIAL<
<TSTMSGCODE128>
<MSGPDF417>
```

Discard Partial Output Sequence

If you want to discard partial sequences when the output sequence operation is terminated before completion, scan **Discard Partial Sequence**.



Default Output Sequence

Default Sequence programs the scanner to all universal values. Be certain you want to delete or clear all formats before you read the **Default Sequence** symbol.



Require Output Sequence

When an output sequence is **Required**, all output data must conform to an edited sequence or the scanner will not transmit the output data to the host device. When it's **On/Not Required**, the scanner will attempt to get the output data to conform to an edited sequence but, if it cannot, the scanner transmits all output data to the host device as is, or formatted according to the partial sequence output format (see [Partial Sequence](#) on page 59).

When the output sequence is **Off**, the bar code data is output to the host as the scanner decodes it. *Default = Off.*

Note: *This selection is unavailable when the Multiple Symbols Selection is turned on.*



No Read

With No Read turned **On**, the scanner notifies you if a code cannot be read. If using an EZConfig-Scanning Tool Scan Data Window (see page 179), an “NR” appears when a code cannot be read. If No Read is turned **Off**, the “NR” will not appear. *Default = Off.*



If you want a different notation than “NR,” for example, “Error,” or “Bad Code,” you can edit the output message (see [Data Format](#) beginning on page 5-71). The hex code for the No Read symbol is 9C.

Video Reverse

Video Reverse is used to allow the scanner to read bar codes that are inverted. The **Video Reverse Off** bar code below is an example of this type of bar code. Scan **Video Reverse Only** to read *only* inverted bar codes. Scan **Video Reverse and Standard Bar Codes** to read both types of codes.

Note: After scanning **Video Reverse Only**, menu bar codes cannot be read. You must scan **Video Reverse Off** or **Video Reverse and Standard Bar Codes** in order to read menu bar codes.

Note: Images downloaded from the unit are not reversed. This is a setting for decoding only.





* Video Reverse Off

Working Orientation

Some bar codes are direction-sensitive. For example, KIX codes and OCR can misread when scanned sideways or upside down. Use the working orientation settings if your direction-sensitive codes will not usually be presented upright to the scanner. *Default = Upright.*

Upright:



Upside Down:



Vertical, Top to Bottom:
(Rotate CW 90°)



Vertical, Bottom to Top:
(Rotate CCW 90°)



ROTATN0.

* Upright



ROTATN2.

Upside Down



ROTATN1.

Vertical, Bottom to Top



ROTATN3.

Vertical, Top to Bottom

Prefix/Suffix Overview

When a bar code is scanned, additional information is sent to the host computer along with the bar code data. This group of bar code data and additional, user-defined data is called a “message string.” The selections in this section are used to build the user-defined data into the message string.

Prefix and Suffix characters are data characters that can be sent before and after scanned data. You can specify if they should be sent with all symbologies, or only with specific symbologies. The following illustration shows the breakdown of a message string:

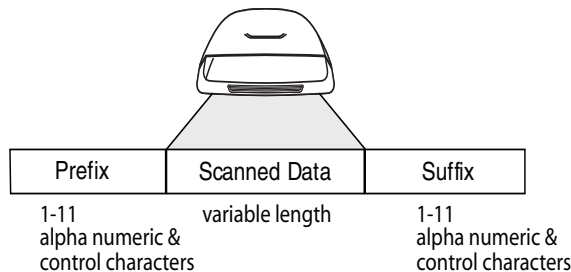

Points to Keep In Mind

- It is not necessary to build a message string. The selections in this chapter are only used if you wish to alter the default settings. *Default prefix = None. Default suffix = None.*
- A prefix or suffix may be added or cleared from one symbology or all symbologies.
- You can add any prefix or suffix from the [ASCII Conversion Chart \(Code Page 1252\)](#), (beginning on page 224), plus Code I.D. and AIM I.D.
- You can string together several entries for several symbologies at one time.
- Enter prefixes and suffixes in the order in which you want them to appear on the output.

- When setting up for specific symbologies (as opposed to all symbologies), the specific symbology ID value counts as an added prefix or suffix character.
- The maximum size of a prefix or suffix configuration is 200 characters, which includes header information.

To Add a Prefix or Suffix:

- Step 1. Scan the **Add Prefix** or **Add Suffix** symbol (page 67).
- Step 2. Determine the 2 digit Hex value from the [Symbology Charts](#), (beginning on page 221) for the symbology to which you want to apply the prefix or suffix. For example, for Code 128, Code ID is “j” and Hex ID is “6A”.
- Step 3. Scan the 2 hex digits from the [Programming Chart](#) or scan **9, 9** for all symbologies.
 - To add the Code I.D., scan **5, C, 8, 0**.
 - To add the AIM I.D., scan **5, C, 8, 1**.
 - To add the serial number, scan **5, C, 8, 8**.
 - To add a backslash (\), scan **5, C, 5, C**.

Note: When adding a backslash (\), you must scan 5C twice – once to create the leading backslash and then to create the backslash itself.

- Step 4. Repeat Steps 2 and 3 for every prefix or suffix character.
 - Step 5. Scan **Save** to exit and save, or scan **Discard** to exit without saving.
- Repeat the steps above to add a prefix or suffix for another symbology.

Example: Add a Tab Suffix to All Symbologies

- Step 1. Scan Add Suffix.
- Step 2. Scan **9, 9** from the [Programming Chart](#) to apply this suffix to all symbologies.
- Step 3. Scan **0, 9** from the [Programming Chart](#). This corresponds with the hex value for a horizontal tab, shown in the [ASCII Conversion Chart \(Code Page 1252\)](#), (beginning on page 224).
- Step 4. Scan **Save**, or scan **Discard** to exit without saving.

Clear One or All Prefixes or Suffixes

You can clear a single prefix or suffix, or clear all prefixes/suffixes for a symbology. If you have been entering prefixes and suffixes for single symbologies, you can use **Clear One Prefix (Suffix)** to delete a specific character from a symbology. When you **Clear All Prefixes (Suffixes)**, all the prefixes or suffixes for a symbology are deleted.

- Step 1. Scan the **Clear One Prefix** or **Clear One Suffix** symbol.
- Step 2. Determine the 2 digit Hex value from the Symbology Chart (included in the [Symbology Charts](#), (beginning on page 221)) for the symbology from which you want to clear the prefix or suffix.
- Step 3. Scan the 2 digit hex value from the [Programming Chart](#) or scan **9, 9** for all symbologies.

Your change is automatically saved.

Add a Carriage Return Suffix to All Symbologies

Scan the following bar code if you wish to add a carriage return suffix to all symbologies at once. This action first clears all current suffixes, then programs a carriage return suffix for all symbologies.



Prefix Selections



Suffix Selections





Function Code Transmit

By default, all ASCII control characters are transmitted with bar code data. These non-printable characters are translated into predefined key strokes, or CTRL+X functions (see [ASCII Conversion Chart \(Code Page 1252\)](#), (beginning on page 224). If these key strokes interfere with your host's software application, scan **Disable** to keep these ASCII control characters from being transmitted. *Default = Enable.*



Note: You can also use a custom data format (see [Data Format](#) beginning on page 71) to translate these characters into a more meaningful output.

Intercharacter, Interfunction, and Intermesssage Delays

Some terminals drop information (characters) if data comes through too quickly. Intercharacter, interfunction, and intermessage delays slow the transmission of data, increasing data integrity.

Intercharacter Delay

An intercharacter delay of up to 5000 milliseconds (in 5ms increments) may be placed between the transmission of each character of scanned data. Scan the **Intercharacter Delay** bar code below, then scan the number of 5ms delays, and the Save bar code using the [Programming Chart](#).

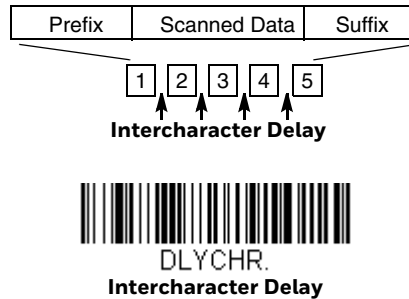

To remove this delay, scan the **Intercharacter Delay** bar code, then set the number of delays to **0**. Scan the **Save** bar code using the [Programming Chart](#).

Note: *Intercharacter delays are not supported in USB serial emulation.*

User Specified Intercharacter Delay

An intercharacter delay of up to 5000 milliseconds (in 5ms increments) may be placed after the transmission of a particular character of scanned data. Scan the **Delay Length** bar code below, then scan the number of 5ms delays, and the **Save** bar code using the [Programming Chart](#).

Next, scan the **Character to Trigger Delay** bar code, then the 2-digit hex value for a printable character to trigger the delay (see [Lower ASCII Reference Table](#) beginning on page A-225).



To remove this delay, scan the **Delay Length** bar code, and set the number of delays to **0**. Scan the **Save** bar code using the [Programming Chart](#).

Interfunction Delay

An interfunction delay of up to 5000 milliseconds (in 5ms increments) may be placed between the transmission of each control character in the message string. Scan the **Interfunction Delay** bar code below, then scan the number of 5ms delays, and the **Save** bar code using the [Programming Chart](#).

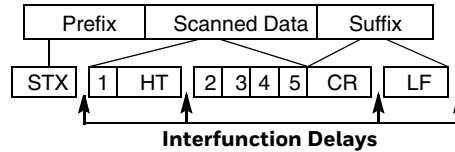

DLYFNC.

Interfunction Delay

To remove this delay, scan the **Interfunction Delay** bar code, then set the number of delays to **0**. Scan the **Save** bar code using the [Programming Chart](#).

Intermessage Delay

An intermessage delay of up to 5000 milliseconds (in 5ms increments) may be placed between each scan transmission. Scan the **Intermessage Delay** bar code below, then scan the number of 5ms delays, and the **Save** bar code using the [Programming Chart](#).

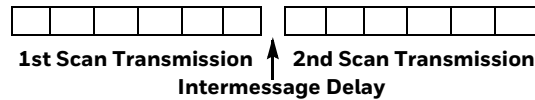

DLYMSG.

Intermessage Delay

To remove this delay, scan the **Intermessage Delay** bar code, then set the number of delays to **0**. Scan the **Save** bar code using the [Programming Chart](#).

Data Format Editor Introduction

You may use the Data Format Editor to change the scanner's output. For example, you can use the Data Format Editor to insert characters at certain points in bar code data as it is scanned. The selections in the following pages are used only if you wish to alter the output. *Default Data Format setting = None.*

Normally, when you scan a bar code, it is output automatically. However, when you create a format, you must use a "send" command (see [Send Commands](#) on page 74) within the format program to output data.

Multiple formats may be programmed into the scanner. They are stacked in the order in which they are entered. However, the following list presents the order in which formats are applied:

1. Specific Terminal ID, Actual Code ID, Actual Length
2. Specific Terminal ID, Actual Code ID, Universal Length
3. Specific Terminal ID, Universal Code ID, Actual Length
4. Specific Terminal ID, Universal Code ID, Universal Length
5. Universal Terminal ID, Actual Code ID, Actual Length
6. Universal Terminal ID, Actual Code ID, Universal Length
7. Universal Terminal ID, Universal Code ID, Actual Length
8. Universal Terminal ID, Universal Code ID, Universal Length

The maximum size of a data format configuration is 2000 bytes, which includes header information.

If a bar code is read that fails the first data format, the next data format, if there is one, will be used on the bar code data. If there is no other data format, the raw data is output.

If you have changed data format settings, and wish to clear all formats and return to the factory defaults, scan the **Default Data Format** code below.



Show Data Format

Scan the bar code below to show current data format settings.



Add a Data Format

- Step 1. Scan the **Enter Data Format** symbol ([page 73](#)).
- Step 2. Select **Primary/Alternate Format**
Determine if this will be your primary data format, or one of 3 alternate formats. This allows you to save a total of 4 different data formats. To program your primary format, scan **0** using the [Programming Chart](#). If you are programming an alternate format, scan **1**, **2**, or **3**, depending on which alternate format you are programming. (See [Primary/Alternate Data Formats](#) on page 88 for further information.)
- Step 3. **Terminal Type**
Refer to [Terminal ID Table](#) (page 74) and locate the Terminal ID number for your PC. Scan three numeric bar codes from the [Programming Chart](#) to program the scanner for your terminal ID (you must enter 3 digits). For example, scan **0 0 3** for an AT wedge.

Note: **099** indicates all terminal types.

- Step 4. **Code I.D.**
In the [Symbology Charts](#), beginning on page 221, find the symbology to which you want to apply the data format. Locate the Hex value for that symbology and scan the 2 digit hex value from the [Programming Chart](#).

If you wish to create a data format for all symbologies, with the exception of some specific symbologies, refer to B8 ([page 86](#)).

If you are creating a data format for Batch Mode Quantity, use 35 for the Code I.D.

Note: **99** indicates all symbologies.

- Step 5. Length
Specify what length (up to 9999 characters) of data will be acceptable for this symbology. Scan the four digit data length from the [Programming Chart](#). For example, 50 characters is entered as 0050.

Note: **9999** indicates all lengths.

Step 6. **Editor Commands**

Refer to [Data Format Editor Commands](#) (page 74). Scan the symbols that represent the command you want to enter.

Step 7. Scan **Save** to save your data format, or **Discard** to exit without saving your changes.



DFMBK3.

Enter Data Format



MNUSAV.

Save



MNUABT.

Discard

Other Programming Selections

- **Clear One Data Format**

This deletes one data format for one symbology. If you are clearing the primary format, scan 0 from the [Programming Chart](#). If you are clearing an alternate format, scan **1**, **2**, or **3**, depending on the format you are clearing. Scan the Terminal Type and Code I.D. (see [Symbology Charts](#) on page 221), and the bar code data length for the specific data format that you want to delete. All other formats remain unaffected.

- **Clear all Data Formats**

This clears all data formats.

- **Save** to exit and save your data format changes.

- **Discard** to exit without saving any data format changes.



DFMCL3.

Clear One Data Format



DFMCA3.

Clear All Data Formats



MNUSAV.

Save



MNUABT.

Discard

Terminal ID Table

Terminal	Model(s)	Terminal ID
USB	PC keyboard (HID)	124
	Mac Keyboard	125
	PC Keyboard (Japanese)	134
	Serial (COM driver required)	130
	HID POS	131
	USB SurePOS Handheld	128
Serial	USB SurePOS Tabletop	129
	RS232 TTL	000
	RS232 True	000
Keyboard	RS485 (IBM-HHBCR 1+2, 46xx)	051
	PS2 compatibles	003

Data Format Editor Commands

When working with the Data Format Editor, a virtual cursor is moved along your input data string. The following commands are used to both move this cursor to different positions, and to select, replace, and insert data into the final output.

Send Commands

Send all characters

- F1** Include in the output message all of the characters from the input message, starting from current cursor position, followed by an insert character. *Syntax = F1xx* where xx stands for the insert character's hex value for its ASCII code. Refer to the [ASCII Conversion Chart \(Code Page 1252\)](#), beginning on page 224 for decimal, hex and character codes.

Send a number of characters

- F2** Include in the output message a number of characters followed by an insert character. Start from the current cursor position and continue for "nn" characters or through the last character in the input message, followed by character "xx." *Syntax = F2nnxx* where nn stands for the numeric value (00-99) for the number of characters, and xx stands for the insert character's hex value for its ASCII code. Refer to the [ASCII Conversion Chart \(Code Page 1252\)](#), beginning on page 224 for decimal, hex and character codes.

F2 Example: Send a number of characters



Send the first 10 characters from the bar code above, followed by a carriage return.
Command string: F2100D

F2 is the “Send a number of characters” command

10 is the number of characters to send

0D is the hex value for a CR

The data is output as: **1234567890**

F2 and F1 Example: Split characters into 2 lines

Send the first 10 characters from the bar code above, followed by a carriage return, followed by the rest of the characters.

Command string: **F2100DF10D**

F2 is the “Send a number of characters” command

10 is the number of characters to send for the first line

0D is the hex value for a CR

F1 is the “Send all characters” command

0D is the hex value for a CR

The data is output as: **1234567890**

ABCDEFGHIJ

<CR>

Send all characters up to a particular character

F3 Include in the output message all characters from the input message, starting with the character at the current cursor position and continuing to, but not including, the search character “ss,” followed by an insert character. The cursor is moved forward to the “ss” character. *Syntax = F3ssxx* where ss stands for the search character’s hex value for its ASCII code, and xx stands for the insert character’s hex value for its ASCII code.

Refer to the [ASCII Conversion Chart \(Code Page 1252\)](#), beginning on page 224 for decimal, hex and character codes.

F3 Example: Send all characters up to a particular character



Using the bar code above, send all characters up to but not including “D,” followed by a carriage return.

Command string: **F3440D**

F3 is the “Send all characters up to a particular character” command

44 is the hex value for a 'D’

0D is the hex value for a CR

The data is output as: **1234567890ABC**
<CR>

Send all characters up to a string

B9 Include in the output message all characters from the input message, starting with the character at the current cursor position and continuing to, but not including, the search string “s...s.” The cursor is moved forward to the beginning of the “s...s” string. *Syntax = B9nnns...s* where nnnn stands for the length of the string, and s...s stands for the string to be matched. The string is made up of hex values for the characters in the string. Refer to the [ASCII Conversion Chart \(Code Page 1252\)](#), beginning on page 224 for decimal, hex and character codes.

B9 Example: Send all characters up to a defined string



Using the bar code above, send all characters up to but not including “AB.”

Command string: **B900024142**

B9 is the “Send all characters up to a string” command

0002 is the length of the string (2 characters)

41 is the hex value for A

42 is the hex value for B

The data is output as: **1234567890**

Send all but the last characters

E9 Include in the output message all but the last “nn” characters, starting from the current cursor position. The cursor is moved forward to one position past the last input message character included. *Syntax = E9nn* where nn stands for the numeric value (00-99) for the number of characters that will not be sent at the end of the message.

Insert a character multiple times

F4 Send “xx” character “nn” times in the output message, leaving the cursor in the current position. *Syntax = F4xxnn* where xx stands for the insert character’s hex value for its ASCII code, and nn is the numeric value (00-99) for the number of times it should be sent. Refer to the [ASCII Conversion Chart \(Code Page 1252\)](#), beginning on page 224 for decimal, hex and character codes.

E9 and F4 Example: Send all but the last characters, followed by 2 tabs



Send all characters except for the last 8 from the bar code above, followed by 2 tabs.

Command string: **E908F40902**

E9 is the “Send all but the last characters” command

08 is the number of characters at the end to ignore

F4 is the “Insert a character multiple times” command

09 is the hex value for a horizontal tab

02 is the number of times the tab character is sent

The data is output as: **1234567890AB <tab><tab>**

Insert a string

BA Send “ss” string of “nn” length in the output message, leaving the cursor in the current position. *Syntax = BAnnnns...s* where nnnn stands for the length of the string, and s...s stands for the string. The string is made up of hex values for the characters in the string. Refer to the [ASCII Conversion Chart \(Code Page 1252\)](#), beginning on page 224 for decimal, hex and character codes.

B9 and BA Example: Look for the string “AB” and insert 2 asterisks ()**



Using the bar code above, send all characters up to but not including “AB.” Insert 2 asterisks at that point, and send the rest of the data with a carriage return after.

Command string: **B900024142BA00022A2AF10D**

B9 is the “Send all characters up to a string” command

0002 is the length of the string (2 characters)

41 is the hex value for A

42 is the hex value for B

BA is the “Insert a string” command

0002 is the length of the string to be added (2 characters)

2A is the hex value for an asterisk (*)

2A is the hex value for an asterisk (*)

F1 is the “Send all characters” command

0D is the hex value for a CR

The data is output as: **1234567890**ABCDEF GHIJ**
<CR>

Insert symbology name

- B3** Insert the name of the bar code’s symbology in the output message, without moving the cursor. Only symbologies with a Honeywell ID are included (see [Symbology Charts](#) on page 221). Refer to the [ASCII Conversion Chart \(Code Page 1252\)](#), beginning on page 224 for decimal, hex and character codes.

Insert bar code length

- B4** Insert the bar code’s length in the output message, without moving the cursor. The length is expressed as a numeric string and does not include leading zeros.

B3 and B4 Example: Insert the symbology name and length



Send the symbology name and length before the bar code data from the bar code above. Break up these insertions with spaces. End with a carriage return.

Command string: **B3F42001B4F42001F10D**

B3 is the “Insert symbology name” command

F4 is the “Insert a character multiple times” command

20 is the hex value for a space

01 is the number of times the space character is sent

B4 is the “Insert bar code length” command

F4 is the “Insert a character multiple times” command

20 is the hex value for a space

01 is the number of times the space character is sent

F1 is the “Send all characters” command

0D is the hex value for a CR

The data is output as: **Code128 20 1234567890ABCDEFGHIJ**
<CR>

Insert key strokes

B5 Insert a key stroke or combination of key strokes. Key strokes are dependent on your keyboard (see [Keyboard Key References](#) on page 231). Any key can be inserted, including arrows and functions. *Syntax* = *B5xxssnn* where *xx* is the number of keys pressed (without key modifiers), *ss* is the key modifier from the table below, and *nn* is the key number from the [Keyboard Key References](#), page 231.

Key Modifiers	
No Key Modifier	00
Shift Left	01
Shift Right	02
Alt Left	04
Alt Right	08
Control Left	10
Control Right	20

For example, B501021F inserts an “A” on a 104 key, U.S. style keyboard. B5 = the command, 01 = number of keys pressed (without the key modifier), 02 is the key modifier for Shift Right, and 1F is the “a” key. If a lower case “a” were to be inserted, B501001F would be entered.

If there are three keystrokes, the syntax would change from B5xxssnn for one key-stroke to B5xxssnnssnnssnn. An example that would insert "abc" is as follows: B503001F00320030F833.

Note: *Key modifiers can be added together when needed. Example: Control Left+Shift Left = 11.*

Move Commands

Move the cursor forward a number of characters

F5 Move the cursor ahead “nn” characters from current cursor position. *Syntax* = *F5nn* where *nn* is the numeric value (00-99) for the number of characters the cursor should be moved ahead.

F5 Example: Move the cursor forward and send the data



Move the cursor forward 3 characters, then send the rest of the bar code data from the bar code above. End with a carriage return.

Command string: **F503F10D**

F5 is the “Move the cursor forward a number of characters” command

03 is the number of characters to move the cursor

F1 is the “Send all characters” command

0D is the hex value for a CR

The data is output as: **4567890ABCDEFGHIJ**
<CR>

Move the cursor backward a number of characters

F6 Move the cursor back “nn” characters from current cursor position. *Syntax = F6nn* where nn is the numeric value (00-99) for the number of characters the cursor should be moved back.

Move the cursor to the beginning

F7 Move the cursor to the first character in the input message. *Syntax = F7.*

FE and F7 Example: Manipulate bar codes that begin with a 1



Search for bar codes that begin with a 1. If a bar code matches, move the cursor back to the beginning of the data and send 6 characters followed by a carriage return. Using the bar code above:

Command string: **FE31F7F2060D**

FE is the “Compare characters” command

31 is the hex value for 1

F7 is the “Move the cursor to the beginning” command

F2 is the “Send a number of characters” command

06 is the number of characters to send

0D is the hex value for a CR

The data is output as: **123456**
<CR>

Move the cursor to the end

EA Move the cursor to the last character in the input message. *Syntax = EA.*

Search Commands

Search forward for a character

F8 Search the input message forward for “xx” character from the current cursor position, leaving the cursor pointing to the “xx” character. *Syntax = F8xx* where xx stands for the search character’s hex value for its ASCII code. Refer to the [ASCII Conversion Chart \(Code Page 1252\)](#), beginning on page 224 for decimal, hex and character codes.

F8 Example: Send bar code data that starts after a particular character



Search for the letter “D” in bar codes and send all the data that follows, including the “D.” Using the bar code above:

Command string: **F844F10D**

F8 is the “Search forward for a character” command

44 is the hex value for “D”

F1 is the “Send all characters” command

0D is the hex value for a CR

The data is output as: **DEFGHIJ**
<CR>

Search backward for a character

F9 Search the input message backward for “xx” character from the current cursor position, leaving the cursor pointing to the “xx” character. *Syntax = F9xx* where xx stands for the search character’s hex value for its ASCII code. Refer to the [ASCII Conversion Chart \(Code Page 1252\)](#), beginning on page 224 for decimal, hex and character codes.

Search forward for a string

B0 Search forward for “s” string from the current cursor position, leaving cursor pointing to “s” string. *Syntax = B0nnnnS* where nnnn is the string length (up to 9999), and S consists of the ASCII hex value of each character in the match string. For example, B0000454657374 will search forward for the first occurrence of the 4 character string “Test.” Refer to the [ASCII Conversion Chart \(Code Page 1252\)](#), beginning on page 224 for decimal, hex and character codes.

B0 Example: Send bar code data that starts after a string of characters



Search for the letters “FGH” in bar codes and send all the data that follows, including “FGH.” Using the bar code above:

Command string: **B00003464748F10D**

B0 is the “Search forward for a string” command

0003 is the string length (3 characters)

46 is the hex value for “F”

47 is the hex value for “G”

48 is the hex value for “H”

F1 is the “Send all characters” command

0D is the hex value for a CR

The data is output as: **FGHIJ**
<CR>

Search backward for a string

- B1** Search backward for “s” string from the current cursor position, leaving cursor pointing to “s” string. *Syntax = B1nnnnS* where nnnn is the string length (up to 9999), and S consists of the ASCII hex value of each character in the match string. For example, B1000454657374 will search backward for the first occurrence of the 4 character string “Test.” Refer to the [ASCII Conversion Chart \(Code Page 1252\)](#), beginning on page 224 for decimal, hex and character codes.

Search forward for a non-matching character

- E6** Search the input message forward for the first non-“xx” character from the current cursor position, leaving the cursor pointing to the non-“xx” character. *Syntax = E6xx* where xx stands for the search character’s hex value for its ASCII code. Refer to the [ASCII Conversion Chart \(Code Page 1252\)](#), beginning on page 224 for decimal, hex and character codes.

E6 Example: Remove zeros at the beginning of bar code data



This example shows a bar code that has been zero filled. You may want to ignore the zeros and send all the data that follows. E6 searches forward for the first character that is not zero, then sends all the data after, followed by a carriage return. Using the bar code above:

Command string: **E630F10D**

E6 is the “Search forward for a non-matching character” command

30 is the hex value for 0

F1 is the “Send all characters” command

0D is the hex value for a CR

The data is output as: **37692**

<CR>

Search backward for a non-matching character

- E7** Search the input message backward for the first non-“xx” character from the current cursor position, leaving the cursor pointing to the non-“xx” character. *Syntax = E7xx* where xx stands for the search character’s hex value for its ASCII code. Refer to the [ASCII Conversion Chart \(Code Page 1252\)](#), beginning on page 224 for decimal, hex and character codes.

Miscellaneous Commands

Suppress characters

- FB** Suppress all occurrences of up to 15 different characters, starting at the current cursor position, as the cursor is advanced by other commands. When the FC command is encountered, the suppress function is terminated. The cursor is not moved by the FB command. *Syntax = FBnnxxyy . .zz* where nn is a count of the number of suppressed characters in the list, and xxyy ..zz is the list of characters to be suppressed.

FB Example: Remove spaces in bar code data



This example shows a bar code that has spaces in the data. You may want to remove the spaces before sending the data. Using the bar code above:

Command string: **FB0120F10D**

FB is the “Suppress characters” command

01 is the number of character types to be suppressed

20 is the hex value for a space

F1 is the “Send all characters” command

0D is the hex value for a CR

The data is output as: **34567890**

<CR>

Stop suppressing characters

- FC** Disables suppress filter and clear all suppressed characters. *Syntax = FC.*

Replace characters

E4 Replaces up to 15 characters in the output message, without moving the cursor. Replacement continues until the E5 command is encountered. *Syntax = E4nnxx₁xx₂yy₁yy₂...zz₁zz₂* where nn is the total count of the number of characters in the list (characters to be replaced plus replacement characters); xx₁ defines characters to be replaced and xx₂ defines replacement characters, continuing through zz₁ and zz₂.

E4 Example: Replace zeros with CRs in bar code data



If the bar code has characters that the host application does not want included, you can use the E4 command to replace those characters with something else. In this example, you will replace the zeros in the bar code above with carriage returns.

Command string: **E402300DF10D**

E4 is the “Replace characters” command

02 is the total count of characters to be replaced, plus the replacement characters (0 is replaced by CR, so total characters = 2)

30 is the hex value for 0

0D is the hex value for a CR (the character that will replace the 0)

F1 is the “Send all characters” command

0D is the hex value for a CR

The data is output as: **1234**

5678

ABC

<CR>

Stop replacing characters

E5 Terminates character replacement. *Syntax = E5.*

Compare characters

FE Compare the character in the current cursor position to the character “xx.” If characters are equal, move the cursor forward one position. *Syntax = FExx* where xx stands for the comparison character’s hex value for its ASCII code. Refer to the [ASCII Conversion Chart \(Code Page 1252\)](#), beginning on page 224 for decimal, hex and character codes.

Compare string

B2 Compare the string in the input message to the string “s.” If the strings are equal, move the cursor forward past the end of the string. *Syntax = B2nnnnS* where nnnn is the string length (up to 9999), and S consists of the ASCII hex value of each character in the match string. For example, B2000454657374 will compare the string at the current cursor position with the 4 character string “Test.” Refer to the [ASCII Conversion Chart \(Code Page 1252\)](#), beginning on page 224 for decimal, hex and character codes.

Check for a number

EC Check to make sure there is an ASCII number at the current cursor position. The format is aborted if the character is not numeric.

EC Example: Only output the data if the bar code begins with a number

If you will only accept data from bar codes that begin with a number, you can use EC to check for the number.

Command string: **ECF10D**

EC is the “Check for a number” command

F1 is the “Send all characters” command

0D is the hex value for a CR

If this bar code is read,  the format fails.
AB1234

If this bar code is read:  the data is output as: **1234AB**
1234AB

<CR>

Check for non-numeric character

ED Check to make sure there is a non-numeric ASCII character at the current cursor position. The format is aborted if the character is numeric.

ED Example: Only output the data if the bar code begins with a letter

If you will only accept data from bar codes that begin with a letter, you can use ED to check for the number.

Command string: **EDF10D**

ED is the “Check for a non-numeric character” command

F1 is the “Send all characters” command

0D is the hex value for a CR

If this bar code is read,  the format fails.

If this bar code is read:  the data is output as: **AB1234**

<CR>

Insert a delay

EF Inserts a delay of up to 49,995 milliseconds (in multiples of 5), starting from the current cursor position. *Syntax = EFnnnn* where nnnn stands for the delay in 5ms increments, up to 9999. This command can only be used with keyboard emulation.

Discard Data

B8 Discards types of data. For example, you may want to discard Code 128 bar codes that begin with the letter A. In step 4 ([page 72](#)), select 6A (for Code 128), and in step 5, select 9999 (for all lengths). Enter FE41B8 to compare and discard Code 128 bar codes that begin with the letter A. *Syntax = B8*.

Note: *The B8 command must be entered after all other commands. The Data Format must be **Required** (see [page 87](#)) in order for the B8 command to work. If Data Format is **On**, but **Not Required** ([page 87](#)), bar code data that meets the B8 format is scanned and output as usual. Other data format settings impact the B8 command. If Data Format Non-Match Error Tone is **On** ([page 88](#)), the scanner emits an error tone. If Data format Non-Match Error Tone is **Off**, the code is disabled for reading and no tone is sounded.*

Data Formatter

When Data Formatter is turned Off, the bar code data is output to the host as read, including prefixes and suffixes.



You may wish to require the data to conform to a data format you have created and saved. The following settings can be applied to your data format:

- **Data Formatter On, Not Required, Keep Prefix/Suffix**
Scanned data is modified according to your data format, and prefixes and suffixes are transmitted.
- **Data Formatter On, Not Required, Drop Prefix/Suffix**
Scanned data is modified according to your data format. If a data format is found for a particular symbol, those prefixes and suffixes are not transmitted. If

a data format is *not* found for that symbol, the prefixes and suffixes are transmitted.

- **Data Format Required, Keep Prefix/Suffix**
Scanned data is modified according to your data format, and prefixes and suffixes are transmitted. Any data that does not match your data format requirements generates an error tone and the data in that bar code is not transmitted. If you wish to process this type of bar code without generating an error tone, see [Data Format Non-Match Error Tone](#).
- **Data Format Required, Drop Prefix/Suffix**
Scanned data is modified according to your data format. If a data format is found for a particular symbol, those prefixes and suffixes are not transmitted. Any data that does not match your data format requirements generates an error tone. If you wish to process this type of bar code without generating an error tone, see [Data Format Non-Match Error Tone](#).

Choose one of the following options. *Default = Data Formatter On, Not Required, Keep Prefix/Suffix.*



DFM_EN1.

*** Data Formatter On,
Not Required,
Keep Prefix/Suffix**



DFM_EN3.

**Data Formatter On,
Not Required,
Drop Prefix/Suffix**



DFM_EN2.

**Data Format Required,
Keep Prefix/Suffix**



DFM_EN4.

**Data Format Required,
Drop Prefix/Suffix**

Data Format Non-Match Error Tone

When a bar code is encountered that doesn't match your required data format, the scanner normally generates an error tone. However, you may want to continue scanning bar codes without hearing the error tone. If you scan the **Data Format Non-Match Error Tone Off** bar code, data that doesn't conform to your data for-

mat is not transmitted, and no error tone will sound. If you wish to hear the error tone when a non-matching bar code is found, scan the **Data Format Non-Match Error Tone On** bar code. *Default = Data Format Non-Match Error Tone On.*



DFMDEC0.

*** Data Format Non-Match Error
Tone On**



DFMDEC1.

**Data Format Non-Match
Error Tone Off**

Primary/Alternate Data Formats

You can save up to four data formats, and switch between these formats. Your primary data format is saved under 0. Your other three formats are saved under **1**, **2**, and **3**. To set your device to use one of these formats, scan one of the bar codes below.



ALTFNM0.

Primary Data Format



ALTFNM1.

Data Format 1



ALTFNM2.

Data Format 2



ALTFNM3.

Data Format 3

Single Scan Data Format Change

You can also switch between data formats for a single scan. The next bar code is scanned using an alternate data format, then reverts to the format you have selected above (either Primary, 1, 2, or 3).

For example, you may have set your device to the data format you saved as Data Format 3. You can switch to Data Format 1 for a single read by scanning the **Single Scan-Data Format 1** bar code below. The next bar code that is scanned uses Data Format 1, then reverts back to Data Format 3.



VSAF_0.

**Single Scan-Primary
Data Format**



VSAF_2.

Single Scan-Data Format 2



VSAF_1.

Single Scan-Data Format 1



VSAF_3.

Single Scan-Data Format 3

SYMBOLOLOGIES

This programming section contains the following menu selections. Refer to [Chapter 11](#) for settings and defaults.

- All Symbolologies
- Aztec Code
- China Post (Hong Kong 2 of 5)
- Chinese Sensible (Han Xin) Code
- Codabar
- Codablock A
- Codablock F
- Code 11
- Code 128
- Code 39 Redundancy
- Code 39
- Code 93
- Data Matrix
- EAN/JAN-13
- EAN/JAN-8
- GS1 Composite Codes
- GS1 DataBar Expanded
- GS1 DataBar Limited
- GS1 DataBar Omnidirectional
- GS1 Emulation
- GS1-128
- Interleaved 2 of 5
- Korea Post
- Matrix 2 of 5
- MaxiCode
- MicroPDF417
- MSI
- NEC 2 of 5
- Postal Codes - 2D
- Postal Codes - Linear
- Label Code
- GS1 DataBar Omnidirectional
- QR Code
- Straight 2 of 5 IATA (two-bar start/stop)
- Straight 2 of 5 Industrial (three-bar start/stop)
- TCIF Linked Code 39 (TLC39)
- Telepen
- Trioptic Code
- UPC-A
- UPC-A/EAN-13 with Extended Coupon Code
- UPC-E0
- UPC-E1

All Symbologies

For best scanner performance, you should only enable the symbologies that you need. Scan **All Symbologies Off** to disable all symbologies, then enable the symbologies you need by scanning the **On** bar code for each symbology.



Message Length Description

You are able to set the valid reading length of some of the bar code symbologies. You may wish to set the same value for minimum and maximum length to force the scanner to read fixed length bar code data. This helps reduce the chances of a mis-read.

Example: Decode only those bar codes with a count of 9-20 characters.
Min. length = 09
Max. length = 20

Example: Decode only those bar codes with a count of 15 characters.
Min. length = 15
Max. length = 15

For a value other than the minimum and maximum message length defaults, scan the bar codes included in the explanation of the symbology, then scan the digit value of the message length and **Save** bar codes on the [Programming Chart](#). The minimum and maximum lengths and the defaults are included with the respective symbologies.

Codabar

<Default All Codabar Settings>



Codabar On/Off





Codabar Start/Stop Characters

Start/Stop characters identify the leading and trailing ends of the bar code. You may either transmit, or not transmit Start/Stop characters. *Default = Don't Transmit.*



Codabar Check Character

Codabar check characters are created using different “modulos.” You can program the scanner to read only Codabar bar codes with Modulo 16 check characters. *Default = No Check Character.*

No Check Character indicates that the scanner reads and transmits bar code data with or without a check character.

When Check Character is set to **Validate and Transmit**, the scanner will only read Codabar bar codes printed with a check character, and will transmit this character at the end of the scanned data.

When Check Character is set to **Validate, but Don't Transmit**, the unit will only read Codabar bar codes printed *with* a check character, but will not transmit the check character with the scanned data.





Codabar Concatenation

Codabar supports symbol concatenation. When you enable concatenation, the scanner looks for a Codabar symbol having a “D” start character, adjacent to a symbol having a “D” stop character. In this case the two messages are concatenated into one with the “D” characters omitted.



Select **Require** to prevent the scanner from decoding a single “D” Codabar symbol without its companion. This selection has no effect on Codabar symbols without Stop/Start D characters.



Codabar Redundancy

If you are encountering errors when reading Codabar bar codes, you may want to adjust the redundancy count. Redundancy adjusts the number of times a bar code is decoded before transmission, which may reduce the number of errors. Note that the higher the redundancy count, the longer it will take to decode the bar code. To adjust the redundancy, scan the following **Codabar Redundancy** bar code, then scan a redundancy count between 0 and 10 on the [Programming Chart](#). Scan [Save](#). *Default = 0.*



Codabar Message Length

Scan the bar codes below to change the message length. Refer to [Message Length Description](#) (page 92) for additional information. Minimum and Maximum lengths = 2-60. Minimum Default = 4, Maximum Default = 60.



Code 39

< Default All Code 39 Settings >



Code 39 On/Off



Code 39 Start/Stop Characters

Start/Stop characters identify the leading and trailing ends of the bar code. You may either transmit, or not transmit Start/Stop characters. *Default = Don't Transmit.*





Code 39 Check Character

No Check Character indicates that the scanner reads and transmits bar code data with or without a check character.

When Check Character is set to **Validate, but Don't Transmit**, the unit only reads Code 39 bar codes printed with a check character, but will not transmit the check character with the scanned data.

When Check Character is set to **Validate and Transmit**, the scanner only reads Code 39 bar codes printed with a check character, and will transmit this character at the end of the scanned data. *Default = No Check Character.*



Code 39 Message Length

Scan the bar codes below to change the message length. Refer to [Message Length Description](#) (page 92) for additional information. Minimum and Maximum lengths = 0-48. Minimum Default = 0, Maximum Default = 48.



Code 39 Append

This function allows the scanner to append the data from several Code 39 bar codes together before transmitting them to the host computer. When the scanner encounters a Code 39 bar code with the append trigger character(s), it buffers Code 39 bar codes until it reads a Code 39 bar code that does not have the append trigger. The data is then transmitted in the order in which the bar codes were read (FIFO). *Default = Off.*



Code 39 Redundancy

If you are encountering errors when reading Code 39 bar codes, you may want to adjust the redundancy count. Redundancy adjusts the number of times a bar code is decoded before transmission, which may reduce the number of errors. Note that the higher the redundancy count, the longer it will take to decode the bar code. To adjust the redundancy, scan the **Code 39 Redundancy** bar code below, then scan a redundancy count between 0 and 10 on the [Programming Chart](#). Scan [Save](#). *Default = 0.*



Code 32 Pharmaceutical (PARAF)

Code 32 Pharmaceutical is a form of the Code 39 symbology used by Italian pharmacies. This symbology is also known as PARAF.

Note: *Trioptic Code (page 131) must be turned off while scanning Code 32 Pharmaceutical codes.*



Full ASCII

If Full ASCII Code 39 decoding is enabled, certain character pairs within the bar code symbol will be interpreted as a single character. For example: \$V will be decoded as the ASCII character SYN, and /C will be decoded as the ASCII character #. *Default = Off.*

Full ASCII Table															
NUL %U	DLE \$P	SP SPACE	0 0	@ %V	P P	' %W	p +P	SOH \$A	DC1 \$Q	! /A	1 1	A A	Q Q	a +A	q +Q
STX \$B	DC2 \$R	" /B	2 2	B B	R R	b +B	r +R	ETX \$C	DC3 \$S	# /C	3 3	C C	S S	c +C	s +S
EOT \$D	DC4 \$T	\$ /D	4 4	D D	T T	d +D	t +T	ENQ \$E	NAK \$U	% /E	5 5	E E	U U	e +E	u +U
ACK \$F	SYN \$V	& /F	6 6	F F	V V	f +F	v +V	BEL \$G	ETB \$W	' /G	7 7	G G	W W	g +G	w +W
BS \$H	CAN \$X	(/H	8 8	H H	X X	h +H	x +X	HT \$I	EM \$Y) /I	9 9	I I	Y Y	i +I	y +Y
LF \$J	SUB \$Z	* /J	: /Z	J J	Z Z	j +J	z +Z	VT \$K	ESC %A	+ /K	; %F	K K	[%K	k +K	{ %P
FF \$L	FS %B	, /L	< %G	L L	\ %L	l +L	%Q	CR \$M	GS %C	- -	= %H	M M] %M	m +M	} %R
SO \$N	RS %D	. .	> %I	N N	^ %N	n +N	~ %S	SI \$O	US %E	/ /O	? %J	O O	_ %O	o +O	DEL %T

Character pairs /M and /N decode as a minus sign and period respectively.
Character pairs /P through /Y decode as 0 through 9.



C39ASCII.
Full ASCII On



C39ASCII.
* Full ASCII Off

Code 39 Code Page

Code pages define the mapping of character codes to characters. If the data received does not display with the proper characters, it may be because the bar code being scanned was created using a code page that is different from the one the host program is expecting. If this is the case, scan the bar code below, select

the code page with which the bar codes were created (see [ISO 2022/ISO 646 Character Replacements](#) on page 228), and scan the value and the **Save** bar code from the [Programming Chart](#). The data characters should then appear properly.



Interleaved 2 of 5

< Default All Interleaved 2 of 5 Settings >



Interleaved 2 of 5 On/Off



Check Digit

No Check Digit indicates that the scanner reads and transmits bar code data with or without a check digit.

When Check Digit is set to **Validate, but Don't Transmit**, the unit only reads Interleaved 2 of 5 bar codes printed with a check digit, but will not transmit the check digit with the scanned data.

When Check Digit is set to **Validate and Transmit**, the scanner only reads Interleaved 2 of 5 bar codes printed with a check digit, and will transmit this digit at the end of the scanned data. *Default = No Check Digit.*





I25CK21.

Validate, but Don't Transmit



I25CK22.

Validate and Transmit

Interleaved 2 of 5 Redundancy

If you are encountering errors when reading Interleaved 2 of 5 bar codes, you may want to adjust the redundancy count. Redundancy adjusts the number of times a bar code is decoded before transmission, which may reduce the number of errors. Note that the higher the redundancy count, the longer it will take to decode the bar code. To adjust the redundancy, scan the **Interleaved 2 of 5 Redundancy** bar code below, then scan a redundancy count between 0 and 10 on the [Programming Chart](#). Scan [Save](#). *Default = 0.*



I25VOT.

Interleaved 2 of 5 Redundancy

Interleaved 2 of 5 Message Length

Scan the bar codes below to change the message length. Refer to [Message Length Description](#) (page 92) for additional information. Minimum and Maximum lengths = 2-80. Minimum Default = 4, Maximum Default = 80.



I25MIN.

Minimum Message Length



I25MAX.

Maximum Message Length

NEC 2 of 5

< Default All NEC 2 of 5 Settings >



N25DFT.

NEC 2 of 5 On/Off



N25ENA1.

*** On**



N25ENAO.

Off

Check Digit

No Check Digit indicates that the scanner reads and transmits bar code data with or without a check digit.

When Check Digit is set to **Validate, but Don't Transmit**, the unit only reads NEC 2 of 5 bar codes printed with a check digit, but will not transmit the check digit with the scanned data.

When Check Digit is set to **Validate and Transmit**, the scanner only reads NEC 2 of 5 bar codes printed with a check digit, and will transmit this digit at the end of the scanned data. *Default = No Check Digit.*



N25CK20.

*** No Check Digit**



N25CK21.

Validate, but Don't Transmit



N25CK22.

Validate and Transmit

NEC 2 of 5 Message Length

Scan the bar codes below to change the message length. Refer to [Message Length Description](#) (page 92) for additional information. Minimum and Maximum lengths = 2-80. Minimum Default = 4, Maximum Default = 80.



N25MIN.

Minimum Message Length



Code 93

< Default All Code 93 Settings >



Code 93 On/Off



Code 93 Message Length

Scan the bar codes below to change the message length. Refer to [Message Length Description](#) (page 92) for additional information. Minimum and Maximum lengths = 0-80. Minimum Default = 0, Maximum Default = 80.



Code 93 Append

This function allows the scanner to append the data from several Code 93 bar codes together before transmitting them to the host computer. When this function is enabled, the scanner stores those Code 93 bar codes that start with a space (excluding the start and stop symbols), and does not immediately transmit the data. The scanner stores the data in the order in which the bar codes are read,

deleting the first space from each. The scanner transmits the appended data when it reads a Code 93 bar code that starts with a character other than a space.
Default = Off.



Code 93 Code Page

Code pages define the mapping of character codes to characters. If the data received does not display with the proper characters, it may be because the bar code being scanned was created using a code page that is different from the one the host program is expecting. If this is the case, scan the bar code below, select the code page with which the bar codes were created (see [ISO 2022/ISO 646 Character Replacements](#) on page 228), and scan the value and the **Save** bar code from the [Programming Chart](#). The data characters should then appear properly.



Straight 2 of 5 Industrial (three-bar start/stop)

<Default All Straight 2 of 5 Industrial Settings>



Straight 2 of 5 Industrial On/Off



Straight 2 of 5 Industrial Message Length

Scan the bar codes below to change the message length. Refer to [Message Length Description](#) (page 92) for additional information. Minimum and Maximum lengths = 1-48. Minimum Default = 4, Maximum Default = 48.



R25MIN.

Minimum Message Length



R25MAX.

Maximum Message Length

Straight 2 of 5 IATA (two-bar start/stop)

<Default All Straight 2 of 5 IATA Settings>



A25DFT.

Straight 2 of 5 IATA On/Off



A25ENA1.

On



A25ENA0.

*** Off**

Straight 2 of 5 IATA Redundancy

If you are encountering errors when reading Straight 2 of 5 IATA bar codes, you may want to adjust the redundancy count. Redundancy adjusts the number of times a bar code is decoded before transmission, which may reduce the number of errors. Note that the higher the redundancy count, the longer it will take to decode the bar

code. To adjust the redundancy, scan the Straight 2 of 5 IATA Redundancy bar code below, then scan a redundancy count between 0 and 10 on the [Programming Chart](#). Then scan the [Save](#) bar code. *Default = 0.*



A25VOT.
Straight 2 of 5 IATA
Redundancy

Straight 2 of 5 IATA Message Length

Scan the bar codes below to change the message length. Refer to [Message Length Description](#) (page 92) for additional information. Minimum and Maximum lengths = 1-48. Minimum Default = 4, Maximum Default = 48.



A25MIN.
Minimum Message Length



A25MAX.
Maximum Message Length

Matrix 2 of 5

<Default All Matrix 2 of 5 Settings>



X25DFT.

Matrix 2 of 5 On/Off



X25ENA1.
On



X25ENA0.
* Off

Matrix 2 of 5 Message Length

Scan the bar codes below to change the message length. Refer to [Message Length Description](#) (page 92) for additional information. Minimum and Maximum lengths = 1-80. Minimum Default = 4, Maximum Default = 80.



Code 11

<Default All Code 11 Settings>



Code 11 On/Off



Check Digits Required

This option sets whether 1 or 2 check digits are required with Code 11 bar codes.
Default = Two Check Digits.





C11CK21.

*** Two Check Digits**

Code 11 Message Length

Scan the bar codes below to change the message length. Refer to [Message Length Description](#) (page 92) for additional information. Minimum and Maximum lengths = 1-80. Minimum Default = 4, Maximum Default = 80.



C11MIN.

Minimum Message Length



C11MAX.

Maximum Message Length

Code 128

<Default All Code 128 Settings>



128DFT.

Code 128 On/Off



128ENA1.

*** On**



128ENA0.

Off

If you are reading Code 128 bar codes, Codablock F should remain disabled. If you are enabling Codablock F (see [Codablock F](#) on page 132), you should disable Code 128.

ISBT 128 Concatenation

In 1994 the International Society of Blood Transfusion (ISBT) ratified a standard for communicating critical blood information in a uniform manner. The use of ISBT formats requires a paid license. The ISBT 128 Application Specification describes 1) the critical data elements for labeling blood products, 2) the current recommendation to use Code 128 due to its high degree of security and its space-efficient design, 3) a variation of Code 128 that supports concatenation of neighboring symbols, and 4) the standard layout for bar codes on a blood product label. Use the bar codes below to turn concatenation on or off. *Default = Off.*



ISBENA1.

On



ISBENA0.

*** Off**

Code 128 Redundancy

If you are encountering errors when reading Code 128 bar codes, you may want to adjust the redundancy count. Redundancy adjusts the number of times a bar code is decoded before transmission, which may reduce the number of errors. Note that the higher the redundancy count, the longer it will take to decode the bar code. To adjust the redundancy, scan the Code 128 Redundancy bar code below, then scan a redundancy count between 0 and 10 on the [Programming Chart](#). Then scan the **Save** bar code. *Default = 0.*



128VOT.

Code 128 Redundancy

Code 128 Message Length

Scan the bar codes below to change the message length. Refer to [Message Length Description](#) (page 92) for additional information. Minimum and Maximum lengths = 0-80. Minimum Default = 0, Maximum Default = 80.



128MIN.

Minimum Message Length



128MAX.

Maximum Message Length

Code 128 Append

This function allows the scanner to append the data from several Code 128 bar codes together before transmitting them to the host computer. When the scanner encounters a Code 128 bar code with the append trigger character(s), it buffers Code 128 bar codes until it reads a Code 128 bar code that does not have the append trigger. The data is then transmitted in the order in which the bar codes were read (FIFO). *Default = Off.*



128APP1.

On



128APP0.

*** Off**

Code 128 Code Page

Code pages define the mapping of character codes to characters. If the data received does not display with the proper characters, it may be because the bar code being scanned was created using a code page that is different from the one the host program is expecting. If this is the case, scan the bar code below, select the code page with which the bar codes were created (see [ISO 2022/ISO 646 Character Replacements](#) on page 228), and scan the value and the Save bar code from the [Programming Chart](#). The data characters should then appear properly.



128DCP.

Code 128 Code Page

GS1-128

<Default All GS1-128 Settings>



GS1DFT.

GS1-128 On/Off



GS1ENA1.

*** On**



GS1-128 Message Length

Scan the bar codes below to change the message length. Refer to [Message Length Description](#) (page 92) for additional information. Minimum and Maximum lengths = 1-80. Minimum Default = 1, Maximum Default = 80.



Telepen

<Default All Telepen Settings>



Telepen On/Off



Telepen Output

Using **AIM Telepen Output**, the scanner reads symbols with start/stop pattern 1 and decodes them as standard full ASCII (start/stop pattern 1). When **Original Telepen Output** is selected, the scanner reads symbols with start/stop pattern 1 and decodes them as compressed numeric with optional full ASCII (start/stop pattern 2). *Default = AIM Telepen Output.*



TELOLD0.

* AIM Telepen Output



TELOLD1.

Original Telepen Output

Telepen Message Length

Scan the bar codes below to change the message length. Refer to [Message Length Description](#) (page 92) for additional information. Minimum and Maximum lengths = 1-60. Minimum Default = 1, Maximum Default = 60.



TELMIN.

Minimum Message Length



TELMAX.

Maximum Message Length

UPC-A

<Default All UPC-A Settings>



UPADFT.

UPC-A On/Off



Note: To convert UPC-A bar codes to EAN-13, see [Convert UPC-A to EAN-13](#) on page 119.

UPC-A Check Digit

This selection allows you to specify whether the check digit should be transmitted at the end of the scanned data or not. *Default = On.*



UPC-A Number System

The numeric system digit of a U.P.C. symbol is normally transmitted at the beginning of the scanned data, but can be programmed so it is not transmitted (**Off**). *Default = On.*



UPC-A Addenda

This selection adds 2 or 5 digits to the end of all scanned UPC-A data.
Default = Off for both 2 Digit and 5 Digit Addenda.



UPAAD21.
2 Digit Addenda On



UPAAD20.
*** 2 Digit Addenda Off**



UPAAD51.
5 Digit Addenda On



UPAAD50.
*** 5 Digit Addenda Off**

UPC-A Addenda Required

When **Required** is scanned, the scanner will only read UPC-A bar codes that have addenda. You must then turn on a 2 or 5 digit addenda listed on [page 113](#). *Default = Not Required.*



UPAARQ1.
Required



UPAARQ0.
*** Not Required**

Addenda Timeout

You can set a time during which the scanner looks for an addenda. If an addenda is not found within this time period, the data can be either transmitted or discarded, based on the setting you are using for [UPC-A Addenda Required](#). Set the length (in

milliseconds) for this timeout by scanning the bar code below, then setting the timeout (from 0-120 milliseconds) by scanning digits from the [Programming Chart](#) of this manual, then **Save**. *Default = 500.*

Note: *The Addenda Timeout setting is applied to all addenda and coupon code searches.*



UPC-A Addenda Separator

When this feature is **On**, there is a space between the data from the bar code and the data from the addenda. When turned **Off**, there is no space. *Default = On.*



UPC-A/EAN-13 with Extended Coupon Code

Use the following codes to enable or disable UPC-A and EAN-13 with Extended Coupon Code. When left on the default setting (**Off**), the scanner treats Coupon Codes and Extended Coupon Codes as single bar codes.

If you scan the **Allow Concatenation** code, when the scanner sees the coupon code and the extended coupon code in a single scan, it transmits both as one symbologies. Otherwise, it transmits the first coupon code it reads.

If you scan the **Require Concatenation** code, the scanner must see and read the coupon code and extended coupon code in a single read to transmit the data. No data is output unless both codes are read. *Default = Off.*





CPNENA2.
Require Concatenation

Coupon GS1 DataBar Output

If you scan coupons that have both UPC and GS1 DataBar codes, you may wish to scan and output only the data from the GS1 DataBar code. Scan the **GS1 Output On** code below to scan and output only the GS1 DataBar code data. *Default = GS1 Output Off.*



CPNGS10.
* **GS1 Output Off**



CPNGS11.
GS1 Output On

UPC-E0

<Default All UPC-E Settings>



UPEDFT.

UPC-E0 On/Off

Most U.P.C. bar codes lead with the 0 number system. To read these codes, use the **UPC-E0 On** selection. If you need to read codes that lead with the 1 number system, use [UPC-E1](#) (page 118). *Default = On.*



UPEEN01.
* **UPC-E0 On**



UPEEN00.
UPC-E0 Off

UPC-E0 Expand

UPC-E Expand expands the UPC-E code to the 12 digit, UPC-A format.
Default = Off.



UPEEXP1.

On



UPEEXP0.

*** Off**

UPC-E0 Addenda Required

When **Required** is scanned, the scanner will only read UPC-E bar codes that have addenda. *Default = Not Required.*



UPEARQ1.

Required



UPEARQ0.

*** Not Required**

Addenda Timeout

You can set a time during which the scanner looks for an addenda. If an addenda is not found within this time period, the data can be either transmitted or discarded, based on the setting you are using for [UPC-E0 Addenda Required](#). Set the length (in milliseconds) for this timeout by scanning the bar code below, then setting the timeout (from 0-120 milliseconds) by scanning digits from the [Programming Chart](#), beginning on page 235 of this manual, then **Save**. *Default = 500.*

Note: *The Addenda Timeout setting is applied to all addenda and coupon code searches.*



DLYADD.

Addenda Timeout

UPC-E0 Addenda Separator

When this feature is **On**, there is a space between the data from the bar code and the data from the addenda. When turned **Off**, there is no space. *Default = On.*



UPEADS1.

*** On**



UPEADS0.

Off

UPC-E0 Check Digit

Check Digit specifies whether the check digit should be transmitted at the end of the scanned data or not. *Default = On.*



UPECKX1.

*** On**



UPECKX0.

Off

UPC-E0 Leading Zero

This feature allows the transmission of a leading zero (0) at the beginning of scanned data. To prevent transmission, scan **Off**. *Default = On.*



UPEXS1.

*** On**



UPEXS0.

Off

UPC-E0 Addenda

This selection adds 2 or 5 digits to the end of all scanned UPC-E data. *Default = Off for both 2 Digit and 5 Digit Addenda.*



UPEAD21.

2 Digit Addenda On



UPEAD20.

*** 2 Digit Addenda Off**



UPEAD51.

5 Digit Addenda On



UPEAD50.

*** 5 Digit Addenda Off**

UPC-E1

Most U.P.C. bar codes lead with the 0 number system. For these codes, use [UPC-E0](#) (page 115). If you need to read codes that lead with the 1 number system, use the **UPC-E1 On** selection. *Default = Off.*



UPEEN11.

UPC-E1 On



UPEEN10.

*** UPC-E1 Off**

EAN/JAN-13

<Default All EAN/JAN Settings>



E13DFT.

EAN/JAN-13 On/Off



E13ENA1.

*** On**



E13ENA0.

Off

Convert UPC-A to EAN-13

When **UPC-A Converted to EAN-13** is selected, UPC-A bar codes are converted to 13 digit EAN-13 codes by adding a zero to the front. When **Do not Convert UPC-A** is selected, UPC-A codes are read as UPC-A.



UPAENA0.

UPC-A Converted to EAN-13



UPAENA1.

*** Do not Convert UPC-A**

EAN/JAN-13 Check Digit

This selection allows you to specify whether the check digit should be transmitted at the end of the scanned data or not. *Default = On.*



E13CKX1.

*** On**



E13CKX0.

Off

EAN/JAN-13 Addenda

This selection adds 2 or 5 digits to the end of all scanned EAN/JAN-13 data.
Default = Off for both 2 Digit and 5 Digit Addenda.



E13AD21.
2 Digit Addenda On



E13AD20.
*** 2 Digit Addenda Off**



E13AD51.
5 Digit Addenda On



E13AD50.
*** 5 Digit Addenda Off**

EAN/JAN-13 Addenda Required

When **Required** is scanned, the scanner will only read EAN/JAN-13 bar codes that have addenda. *Default = Not Required.*



E13ARQ1.
Required



E13ARQ0.
*** Not Required**

EAN-13 Beginning with 290 Addenda Required

This setting programs the scanner to require a 5 digit addenda on EAN-13 bar codes that begin with “290.” The following settings can be programmed:

Require 5 Digit Addenda: All EAN-13 bar codes that begin with a “290” must have a 5 digit addendum. The EAN-13 bar code with the 5 digit addendum is then transmitted as a single, concatenated bar code. If a 5 digit addendum is not found within the [Addenda Timeout](#) period, the EAN-13 bar code is discarded.

Don't Require 5 Digit Addenda: If you have selected **Require 5 Digit Addenda** and you want to disable this feature, scan **Don't Require 5 Digit Addenda**. EAN-13 bar codes are transmitted, depending on the setting you are using for [EAN/JAN-13 Addenda Required](#).

Default = Don't Require 5 Digit Addenda.



* Don't Require 5 Digit Addenda



Require 5 Digit Addenda

EAN-13 Beginning with 378/379 Addenda Required

This setting programs the scanner to require any combination of a 2 digit addenda or a 5 digit addenda on EAN-13 bar codes that begin with a "378" or "379." The following settings can be programmed:

Require Addenda: All EAN-13 bar codes that begin with a "378" or "379" must have a 2 digit addenda, a 5 digit addenda, or a combination of these addenda. The EAN-13 bar code with the addenda is then transmitted as a single, concatenated bar code. If the required addenda is not found within the [Addenda Timeout](#) period, the EAN-13 bar code is discarded.

Don't Require Addenda: If you have selected **Require Addenda**, and you want to disable this feature, scan **Don't Require Addenda**. EAN-13 bar codes are transmitted, depending on the setting you are using for [EAN/JAN-13 Addenda Required](#).

Default = Don't Require Addenda.



* Don't Require Addenda



Require 2 Digit Addenda



Require 5 Digit Addenda



Require 2 or 5 Digit Addenda

EAN-13 Beginning with 414/419 Addenda Required

This setting programs the scanner to require any combination of a 2 digit addenda or a 5 digit addenda on EAN-13 bar codes that begin with a “414” or “419.” The following settings can be programmed:

Require Addenda: All EAN-13 bar codes that begin with a “414” or “419” must have a 2 digit addenda, a 5 digit addenda, or a combination of these addenda. The EAN-13 bar code with the addenda is then transmitted as a single, concatenated bar code. If the required addenda is not found within the [Addenda Timeout](#) period, the EAN-13 bar code is discarded.

Don't Require Addenda: If you have selected Require Addenda, and you want to disable this feature, scan **Don't Require Addenda**. EAN-13 bar codes are transmitted, depending on the setting you are using for [EAN/JAN-13 Addenda Required](#).

Default = Don't Require Addenda.



ARQ4140.

* Don't Require Addenda



ARQ4141.

Require 2 Digit Addenda



ARQ4142.

Require 5 Digit Addenda



ARQ4143.

Require 2 or 5 Digit Addenda

EAN-13 Beginning with 977 Addenda Required

This setting programs the scanner to require a 2 digit addenda only on EAN-13 bar codes that begin with “977.” The following settings can be programmed:

Require 2 Digit Addenda: All EAN-13 bar codes that begin with “977” must have a 2 digit addendum. The EAN-13 bar code with the 2 digit addendum is then transmitted as a single, concatenated bar code. If a 2 digit addendum is not found within the [Addenda Timeout](#) period, the EAN-13 bar code is discarded.

Don't Require 2 Digit Addenda: If you have selected Require 2 Digit Addenda, and you want to disable this feature, scan **Don't Require 2 Digit Addenda**. EAN-13 bar codes are transmitted, depending on the setting you are using for [EAN/JAN-13 Addenda Required](#).

Default = Don't Require 2 Digit Addenda.



ARQ9770.

* Don't Require 2 Digit Addenda



ARQ9771.

Require 2 Digit Addenda

EAN-13 Beginning with 978 Addenda Required

These settings program the scanner to require a 5 digit addenda only on EAN-13 bar codes that begin with “978.” The following settings can be programmed:

Require 5 Digit Addenda: All EAN-13 bar codes that begin with “978” must have a 5 digit addendum. The EAN-13 bar code with the 5 digit addendum is then transmitted as a single, concatenated bar code. If a 5 digit addendum is not found within the [Addenda Timeout](#) period, the EAN-13 bar code is discarded.

Don't Require 5 Digit Addenda: If you have selected Require 5 Digit Addenda, and you want to disable this feature, scan **Don't Require 5 Digit Addenda**. EAN-13 bar codes are transmitted, depending on the setting you are using for [EAN/JAN-13 Addenda Required](#).

Default = Don't Require 5 Digit Addenda.



ARQ9780.

* Don't Require 5 Digit Addenda



ARQ9781.

Require 5 Digit Addenda

EAN-13 Beginning with 979 Addenda Required

These settings program the scanner to require a 5 digit addenda only on EAN-13 bar codes that begin with “979.” The following settings can be programmed:

Require 5 Digit Addenda: All EAN-13 bar codes that begin with “979” must have a 5 digit addendum. The EAN-13 bar code with the 5 digit addendum is then transmitted as a single, concatenated bar code. If a 5 digit addendum is not found within the [Addenda Timeout](#) period, the EAN-13 bar code is discarded.

Don't Require 5 Digit Addenda: If you have selected Require 5 Digit Addenda, and you want to disable this feature, scan **Don't Require 5 Digit Addenda**. EAN-13 bar codes are transmitted, depending on the setting you are using for [EAN/JAN-13 Addenda Required](#).

Default = Don't Require 5 Digit Addenda.



* Don't Require 5 Digit Addenda



Require 5 Digit Addenda

Addenda Timeout

You can set a time during which the scanner looks for an addenda. If an addenda is not found within this time period, the data can be either transmitted or discarded, based on the setting you are using for [EAN/JAN-13 Addenda Required](#). Set the length (in milliseconds) for this timeout by scanning the bar code below, then setting the timeout (from 0-120 milliseconds) by scanning digits from the [Programming Chart](#), beginning on page 235 of this manual, then **Save**. *Default = 500.*

Note: *The Addenda Timeout setting is applied to all addenda and coupon code searches.*



Addenda Timeout

EAN/JAN-13 Addenda Separator

When this feature is **On**, there is a space between the data from the bar code and the data from the addenda. When turned **Off**, there is no space. *Default = On.*



* On



Off

Note: *If you want to enable or disable EAN13 with Extended Coupon Code, refer to [UPC-A/EAN-13 with Extended Coupon Code](#) (page 114).*

ISBN Translate

When **On** is scanned, EAN-13 Bookland symbols are translated into their equivalent ISBN number format. *Default = Off.*



E13ISB1.

On



E13ISB0.

*** Off**

EAN/JAN-8

<Default All EAN/JAN-8 Settings>



EABDFT.

EAN/JAN-8 On/Off



EABENA1.

*** On**



EABENA0.

Off

EAN/JAN-8 Check Digit

This selection allows you to specify whether the check digit should be transmitted at the end of the scanned data or not. *Default = On.*



EABCKX1.

*** On**



EABCKX0.

Off

EAN/JAN-8 Addenda

This selection adds 2 or 5 digits to the end of all scanned EAN/JAN-8 data. *Default = Off for both 2 Digit and 5 Digit Addenda.*



EABAD21.
2 Digit Addenda On



EABAD20.
*** 2 Digit Addenda Off**



EABAD51.
5 Digit Addenda On



EABAD50.
*** 5 Digit Addenda Off**

EAN/JAN-8 Addenda Required

When **Required** is scanned, the scanner will only read EAN/JAN-8 bar codes that have addenda. *Default = Not Required.*



EABARQ1.
Required



EABARQ0.
*** Not Required**

Addenda Timeout

You can set a time during which the scanner looks for an addenda. If an addenda is not found within this time period, the data can be either transmitted or discarded, based on the setting you are using for [EAN/JAN-8 Addenda Required](#). Set the length (in milliseconds) for this timeout by scanning the bar code below, then set-

ting the timeout (from 0-120 milliseconds) by scanning digits from the [Programming Chart](#), beginning on page 235 of this manual, then **Save**. *Default = 500.*

Note: *The Addenda Timeout setting is applied to all addenda and coupon code searches.*



EAN/JAN-8 Addenda Separator

When this feature is **On**, there is a space between the data from the bar code and the data from the addenda. When turned **Off**, there is no space. *Default = On.*



MSI

<Default All MSI Settings>



MSI On/Off



MSI Check Character

Different types of check characters are used with MSI bar codes. You can program the scanner to read MSI bar codes with Type 10 check characters. *Default = Validate Type 10, but Don't Transmit.*

When Check Character is set to **Validate Type 10/11 and Transmit**, the scanner will only read MSI bar codes printed with the specified type check character(s), and will transmit the character(s) at the end of the scanned data.

When Check Character is set to **Validate Type 10/11, but Don't Transmit**, the unit will only read MSI bar codes printed with the specified type check character(s), but will not transmit the check character(s) with the scanned data.



MSCHK0.

* **Validate Type 10, but Don't Transmit**



MSCHK1.

Validate Type 10 and Transmit



MSCHK2.

Validate 2 Type 10 Characters, but Don't Transmit



MSCHK3.

Validate 2 Type 10 Characters and Transmit



MSCHK4.

Validate Type 11 then Type 10 Character, but Don't Transmit



MSCHK5.

Validate Type 11 then Type 10 Character and Transmit



MSCHK6.

Disable MSI Check Characters

MSI Message Length

Scan the bar codes below to change the message length. Refer to [Message Length Description](#) (page 92) for additional information. Minimum and Maximum lengths = 4-48. Minimum Default = 4, Maximum Default = 48.



GS1 DataBar Omnidirectional

< Default All GS1 DataBar Omnidirectional Settings >



GS1 DataBar Omnidirectional On/Off



GS1 DataBar Limited

< Default All GS1 DataBar Limited Settings >



GS1 DataBar Limited On/Off



GS1 DataBar Expanded

< Default All GS1 DataBar Expanded Settings >



GS1 DataBar Expanded On/Off



GS1 DataBar Expanded Message Length

Scan the bar codes below to change the message length. Refer to [Message Length Description](#) (page 92) for additional information. Minimum and Maximum lengths = 4-74. Minimum Default = 4, Maximum Default = 74.



Trioptic Code

Note: If you are going to scan Code 32 Pharmaceutical codes ([page 97](#)), Trioptic Code must be off.

Trioptic Code is used for labeling magnetic storage media.



Codablock A

<Default All Codablock A Settings>



Codablock A On/Off



If you are reading Code 39 bar codes, Codablock A should remain disabled. If you are enabling Codablock A, you should disable Code 39 (see [Code 39](#) on page 95).

Codablock A Message Length

Scan the bar codes below to change the message length. Refer to [Message Length Description](#) (page 92) for additional information. Minimum and Maximum lengths = 1-600. Minimum Default = 1, Maximum Default = 600.



CBAMIN.

Minimum Message Length



CBAMAX.

Maximum Message Length

Codablock F

<Default All Codablock F Settings>



CBFDFT.

Codablock F On/Off



CBFENA1.

On



CBFENA0.

*** Off**

Codablock F Message Length

Scan the bar codes below to change the message length. Refer to [Message Length Description](#) (page 92) for additional information. Minimum and Maximum lengths = 1-2048. Minimum Default = 1, Maximum Default = 2048.



CBFMIN.

Minimum Message Length



Label Code

The standard Label Code is used in libraries. *Default = Off.*



PDF417

< *Default All PDF417 Settings* >



PDF417 On/Off



PDF417 Message Length

Scan the bar codes below to change the message length. Refer to [Message Length Description](#) (page 92) for additional information. Minimum and Maximum lengths = 1-2750. Minimum Default = 1, Maximum Default = 2750.



MacroPDF417

MacroPDF417 is an implementation of PDF417 capable of encoding very large amounts of data into multiple PDF417 bar codes. When this selection is enabled, these multiple bar codes are assembled into a single data string. *Default = On.*



MicroPDF417

< Default All MicroPDF417 Settings >



MicroPDF417 On/Off





MicroPDF417 Message Length

Scan the bar codes below to change the message length. Refer to [Message Length Description](#) (page 92) for additional information. Minimum and Maximum lengths = 1-366. Minimum Default = 1, Maximum Default = 366.



GS1 Composite Codes

Linear codes are combined with a unique 2D composite component to form a new class called GS1 Composite symbology. GS1 Composite symbologies allow for the co-existence of symbologies already in use. *Default = Off.*



UPC/EAN Version

Scan the **UPC/EAN Version On** bar code to decode GS1 Composite symbols that have a U.P.C. or an EAN linear component. (This does not affect GS1 Composite symbols with a GS1-128 or GS1 linear component.) *Default = UPC/EAN Version Off.*



Note: *If you scan coupons that have both UPC and GS1 DataBar codes, you may wish to scan and output only the data from the GS1 DataBar code. See [Coupon GS1 DataBar Output](#) (page 115) for further information.*

GS1 Composite Code Message Length

Scan the bar codes below to change the message length. Refer to [Message Length Description](#) (page 92) for additional information. Minimum and Maximum lengths = 1-2435. Minimum Default = 1, Maximum Default = 2435.



GS1 Emulation

The scanner can automatically format the output from any GS1 data carrier to emulate what would be encoded in an equivalent GS1-128 or GS1 DataBar symbol. GS1 data carriers include UPC-A and UPC-E, EAN-13 and EAN-8, ITF-14, GS1-128, and GS1-128 DataBar and GS1 Composites. (Any application that accepts GS1 data can be simplified since it only needs to recognize one data carrier type.)

If **GS1-128 Emulation** is scanned, all retail codes (U.P.C., UPC-E, EAN8, EAN13) are expanded out to 16 digits. If the AIM ID is enabled, the value will be the GS1-128 AIM ID,]C1 (see [Symbology Charts](#) on page 221).

If **GS1 DataBar Emulation** is scanned, all retail codes (U.P.C., UPC-E, EAN8, EAN13) are expanded out to 16 digits. If the AIM ID is enabled, the value will be the GS1-DataBar AIM ID,]em (see [Symbology Charts](#) on page 221).

If **GS1 Code Expansion Off** is scanned, retail code expansion is disabled, and UPC-E expansion is controlled by the [UPC-E0 Expand](#) (page 116) setting. If the AIM ID is enabled, the value will be the GS1-128 AIM ID,]C1 (see [Symbology Charts](#) on page 221).

If **EAN8 to EAN13 Conversion** is scanned, all EAN8 bar codes are converted to EAN13 format.

Default = GS1 Emulation Off.



EANEMU1.
GS1-128 Emulation



EANEMU2.
GS1 DataBar Emulation



EANEMU3.
GS1 Code Expansion Off



EANEMU4.
EAN8 to EAN13 Conversion



EANEMU0.
*** GS1 Emulation Off**

TCIF Linked Code 39 (TLC39)

This code is a composite code since it has a Code 39 linear component and a MicroPDF417 stacked code component. All bar code readers are capable of reading the Code 39 linear component. The MicroPDF417 component can only be decoded if TLC39 **On** is selected. The linear component may be decoded as Code 39 even if TLC39 is off. *Default = Off.*



T39ENA1.
On



T39ENA0.
*** Off**

QR Code

< Default All QR Code Settings >



QR Code On/Off

This selection applies to both QR Code and Micro QR Code.



QR Code Message Length

Scan the bar codes below to change the message length. Refer to [Message Length Description](#) (page 92) for additional information. Minimum and Maximum lengths = 1-7089. Minimum Default = 1, Maximum Default = 7089.



QR Code Append

This function allows the scanner to append the data from several QR Code bar codes together before transmitting them to the host computer. When the scanner encounters an QR Code bar code with the append trigger character(s), it buffers the number of QR Code bar codes determined by information encoded in those bar codes. Once the proper number of codes is reached, the data is output in the order specified in the bar codes. There are 3 ways to scan appended QR Code:

One Scan: Pull the trigger one time and all appended QR Codes in the same image are decoded

Swipe: Pull and hold down the trigger and scan all appended QR Codes while keeping the trigger pressed. The scanner emits short beeps for each partial QR Code that is scanned and buffered. One long beep is emitted after the last QR Code is scanned and the data is complete. Not compatible with Presentation mode.

Point and Shoot: Pull the trigger one time for each image. The scanner emits a short beep for each partial QR Code that is scanned and buffered. One long beep is emitted after the last QR Code is scanned and the data is complete. Not compatible with Presentation mode.

Default = One Scan.



QRCAPP1.
* One Scan



QRCAPP2.
Swipe



QRCAPP3.
Point and Shoot



QRCAPP0.
Off

QR Code Page

QR Code pages define the mapping of character codes to characters. If the data received does not display with the proper characters, it may be because the bar code being scanned was created using a code page that is different from the one the host program is expecting. If this is the case, scan the bar code below, select the code page with which the bar codes were created (see [ISO 2022/ISO 646 Character Replacements](#) on page 228), and scan the value and the Save bar code from the [Programming Chart](#). The data characters should then appear properly.



QRCDCP.
QR Code Page

Data Matrix

< Default All Data Matrix Settings >



IDMDFT.

Data Matrix On/Off



IDMENA1.
*** On**



IDMENA0.
Off

Data Matrix Message Length

Scan the bar codes below to change the message length. Refer to [Message Length Description](#) (page 92) for additional information. Minimum and Maximum lengths = 1-3116. Minimum Default = 1, Maximum Default = 3116.



IDMMIN.
Minimum Message Length



IDMMAX.
Maximum Message Length

Data Matrix Append

This function allows the scanner to append the data from several Data Matrix bar codes together before transmitting them to the host computer. When the scanner encounters an Data Matrix bar code with the append trigger character(s), it buffers the number of Data Matrix bar codes determined by information encoded in those bar codes. Once the proper number of codes is reached, the data is output in the order specified in the bar codes. *Default = On.*



IDMAPP1.
*** On**



IDMAPP0.
Off

Data Matrix Code Page

Data Matrix Code pages define the mapping of character codes to characters. If the data received does not display with the proper characters, it may be because the bar code being scanned was created using a code page that is different from the one the host program is expecting. If this is the case, scan the bar code below, select the code page with which the bar codes were created (see [ISO 2022/ISO 646 Character Replacements](#) on page 228), and scan the value and the Save bar code from the [Programming Chart](#). The data characters should then appear properly.



IDMDCP.

Data Matrix Code Page

MaxiCode

< Default All MaxiCode Settings >



MAXDFT.

MaxiCode On/Off



MAXENA1.

On



MAXENA0.

*** Off**

MaxiCode Message Length

Scan the bar codes below to change the message length. Refer to [Message Length Description](#) (page 92) for additional information. Minimum and Maximum lengths = 1-150. Minimum Default = 1, Maximum Default = 150.



MAXMIN.

Minimum Message Length



MAXMAX.

Maximum Message Length

Aztec Code

< Default All Aztec Code Settings >



Aztec Code On/Off



Aztec Code Message Length

Scan the bar codes below to change the message length. Refer to [Message Length Description](#) (page 92) for additional information. Minimum and Maximum lengths = 1-3832. Minimum Default = 1, Maximum Default = 3832.



Aztec Append

This function allows the scanner to append the data from several Aztec bar codes together before transmitting them to the host computer. When the scanner encounters an Aztec bar code with the append trigger character(s), it buffers the number of Aztec bar codes determined by information encoded in those bar codes. Once the proper number of codes is reached, the data is output in the order specified in the bar codes. *Default = On.*





Aztec Code Page

Aztec Code pages define the mapping of character codes to characters. If the data received does not display with the proper characters, it may be because the bar code being scanned was created using a code page that is different from the one the host program is expecting. If this is the case, scan the bar code below, select the code page with which the bar codes were created (see [ISO 2022/ISO 646 Character Replacements](#) on page 228), and scan the value and the Save bar code from the [Programming Chart](#). The data characters should then appear properly.



Chinese Sensible (Han Xin) Code

< Default All Han Xin Settings >



Han Xin Code On/Off



Han Xin Code Message Length

Scan the bar codes below to change the message length. Refer to [Message Length Description](#) (page 92) for additional information. Minimum and Maximum lengths = 1-7833. Minimum Default = 1, Maximum Default = 7833.



Postal Codes - 2D

The following lists the possible 2D postal codes, and 2D postal code combinations that are allowed. Only one 2D postal code selection can be active at a time. If you scan a second 2D postal code selection, the first selection is overwritten. *Default = 2D Postal Codes Off.*



Single 2D Postal Codes:





POSTAL3.
Japanese Post On



POSTAL4.
KIX Post On



POSTAL5.
Planet Code On
Also see [Planet](#)



POSTAL9.
Postal-4i On



POSTAL6.
Postnet On
Also see [Postnet](#)



POSTAL11.
Postnet with B and B' Fields On



POSTAL2.
InfoMail On

Combination 2D Postal Codes:



POSTAL8.
InfoMail and British
Post On



POSTAL20.
Intelligent Mail Bar Code and
Postnet with B and B' Fields On



POSTAL14.
Postnet and
Postal-4i On



POSTAL17.
Postal-4i and
Intelligent Mail Bar Code On



POSTAL12.
Planet Code and
Postnet On



POSTAL13.
Planet Code and
Postal-4i On



POSTAL21.
Planet Code,
Postnet, and
Postal-4i On



POSTAL16.
Postnet and
Intelligent Mail Bar Code On



POSTAL19.
Postal-4i and
Postnet with B and B' Fields On



POSTAL18.
Planet Code and
Postnet with B and B' Fields On



POSTAL15.
Planet Code and
Intelligent Mail Bar Code



POSTAL22.
Planet Code,
Postnet, and
Intelligent Mail Bar Code On



POSTAL23.
Planet Code,
Postal-4i, and
Intelligent Mail Bar Code On



POSTAL24.
Postnet,
Postal-4i, and
Intelligent Mail Bar Code On



POSTAL25.
Planet Code,
Postal-4i, and
Postnet with B and B' Fields On



POSTAL26.
Planet Code,
Intelligent Mail Bar Code, and
Postnet with B and B' Fields On



POSTAL27.
Postal-4i,
Intelligent Mail Bar Code, and
Postnet with B and B' Fields On



POSTAL28.
Planet Code,
Postal-4i,
Intelligent Mail Bar Code, and
Postnet On



POSTAL29.
Planet Code,
Postal-4i,
Intelligent Mail Bar Code, and
Postnet with B and B' Fields On

Planet Code Check Digit

This selection allows you to specify whether the check digit should be transmitted at the end of Planet Code data. *Default = Don't Transmit.*



PLNCKX1.
Transmit Check Digit



Postnet Check Digit

This selection allows you to specify whether the check digit should be transmitted at the end of Postnet data. *Default = Don't Transmit.*



Australian Post Interpretation

This option controls what interpretation is applied to customer fields in Australian 4-State symbols.

Bar Output lists the bar patterns in "0123" format.

Numeric N Table causes that field to be interpreted as numeric data using the N Table.

Alphanumeric C Table causes the field to be interpreted as alphanumeric data using the C Table. Refer to the Australian Post Specification Tables.

Combination C and N Tables causes the field to be interpreted using either the C or N Tables.





Postal Codes - Linear

The following lists linear postal codes. Any combination of linear postal code selections can be active at a time.

China Post (Hong Kong 2 of 5)

<Default All China Post (Hong Kong 2 of 5) Settings>



China Post (Hong Kong 2 of 5) On/Off



China Post (Hong Kong 2 of 5) Message Length

Scan the bar codes below to change the message length. Refer to [Message Length Description](#) (page 92) for additional information. Minimum and Maximum lengths = 2-80. Minimum Default = 4, Maximum Default = 80.



Korea Post

<Default All Korea Post Settings>



Korea Post



Korea Post Message Length

Scan the bar codes below to change the message length. Refer to [Message Length Description](#) (page 92) for additional information. Minimum and Maximum lengths = 2-80. Minimum Default = 4, Maximum Default = 48.



Korea Post Check Digit

This selection allows you to specify whether the check digit should be transmitted.
Default = Don't Transmit.



EAS Considerations

Do not install any large iron fixtures, such as steel support poles, near the Solaris 7980g. Doing so may re-shape the EAS tag deactivation field.

Note: *The 7980GEL does not support the EAS interface.*

EAS Deactivation

The Solaris 7980g supports deactivation of Checkpoint and Sensormatic/Tyco EAS tags. The following illustration shows the location of the EAS deactivation area. It is important to pass the entire tag through this area to deactivate the security tag.

Note: *Do not store tags within 18.0 in (45.7cm) of the Solaris 7980g. Tags stored closer than 18.0 in (45.7cm) may be unintentionally deactivated. This area also includes storage areas located under the Solaris 7980g.*

EAS Deactivation Zone

The entire tag must pass through the EAS deactivation area.

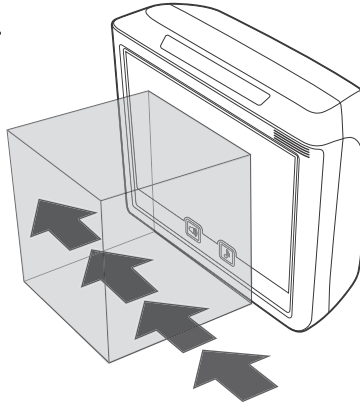

EAS Deactivation Range

Scan the bar code below to set the 1D bar code depth of field within the EAS Deactivation range.

Note: *The minimum element width changes to 6.8 mil when in EAS Deactivation Range mode.*



PDCPP123.

EAS Deactivation Range

Sensormatic

Contact Tyco for further information about Sensormatic installation and configuration.

Checkpoint

EAS Controller Settings

The following switch settings for a Checkpoint Counterpoint IX controller can be used as a starting point, however, these settings should be tuned according to your particular installation.

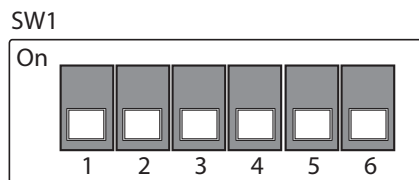
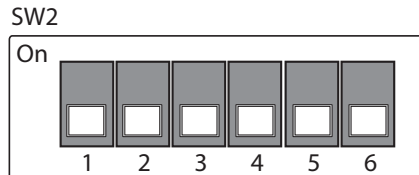

EAS Controller

Scan one of the following bar codes to select the EAS system that is attached to the scanner. *Default = Off.*



EAS Mode of Operation

Scan one of the following bar codes to select the EAS mode you wish to use.

When **Interlocked** is selected, EAS tag deactivation is interlocked with bar code scanning and transmission. When using Interlocked, you must set the timeout (see below).

When **Continuous on Enable** is selected, EAS tag deactivation is on all the time.

Default = Interlocked.



EASMODE0.
*** Interlocked**



EASMODE1.
Continuous on Enable

EAS Interlocked Duration Timeout

When using the Interlocked EAS Mode of Operation, you must set the lag time between when a bar code is read and when the EAS tag is deactivated. Use this selection to set this timeout (in milliseconds). After scanning the **EAS Interlocked Duration Timeout** bar code, set the timeout duration (from 1-5000 milliseconds) by scanning digits on the [Programming Chart](#) inside the back cover, then scanning *Save*. *Default = 100 ms, which is 0.1 second.*



EASTIM.
**EAS Interlocked Duration
Timeout**

PROGRAM AN AUXILIARY SCANNER

Introduction

This chapter describes how to program auxiliary scanners that will be connected to the Solaris scanner.

Note: *The 7980GEL does not support an Auxiliary Scanner.*

Connect by USB Serial

The Solaris 7980g auxiliary port supports Honeywell hand-held scanners with a menu system. Scan the following code to configure the Honeywell hand-held scanner for the auxiliary port:



TRMUSB130.

USB Serial

No extra configuration (e.g., baud rate) is necessary.

Note: *Once the auxiliary scanner is configured for USB Serial, do not scan any configuration codes with the auxiliary scanner.*

Connect by USB Keyboard

The Solaris 7980g auxiliary port supports Honeywell or third party hand-held scanners that support a USB Keyboard interface. Follow the steps below to configure the auxiliary scanner. Contact the nearest technical support office (see [Technical Assistance](#) on page xi) for further information.

Note: *We recommend using Honeywell hand-held scanners. Non-Honeywell, or third party, scanners may not work with the Solaris 7980g.*

1. Configure the scanner to USB Keyboard interface.
2. Configure the scanner to output AIM I.D.
3. Configure the scanner to output CR Suffix.
4. Set the Keyboard Country Layout to U.S.A.

Note: *Once the auxiliary scanner is configured for USB Keyboard, do not scan any configuration codes with the auxiliary scanner.*

IMAGING COMMANDS

The scanner is like a digital camera in the way it captures, manipulates, and transfers images. The following commands allow you to alter the way the scanner performs these functions.

Note: You must set the scanner a [Serial Trigger Mode](#) (page 41) in order to take images.

Single-Use Basis

Imaging Commands with their modifiers send instructions to the scanner on a single-use basis, and take effect for a single image capture. Once that capture is complete, the scanner reverts to its imaging default settings. If you want to permanently change a setting, you must use the serial default commands (see [Serial Programming Commands](#), beginning on page 183). When the serial default command is used, that selection becomes the new, permanent setting for the scanner.

Command Syntax

Multiple modifiers and commands can be issued within one sequence. If additional modifiers are to be applied to the same command, just add the modifiers to that command. For example, to add 2 modifiers to the Image Snap command, such as setting the Imaging Style to 1P and the Wait for Trigger to 1T, you would enter **IMGSNP1P1T**.

Note: After processing an image capture command (*IMGSNP* or *IMGBOX*), you must follow it with an *IMGSHIP* command if you want to see it on your terminal.

To add a command to a sequence, each new command is separated with a semicolon. For example, to add the Image Ship command to the above sequence, you would enter `IMGSNP1P1T;IMGSHIP`.

The imaging commands are:

[Image Snap - IMGSNP](#) (page 158)

[Image Ship - IMGSHIP](#) (page 161)

[Intelligent Signature Capture - IMGBOX](#) (page 171)

The modifiers for each of these commands follow the command description.

Note: *The images included with each command description are examples only. The results you achieve may be different from those included in this manual. The quality of the output you receive will vary depending on lighting, quality of the initial image/object being captured, and distance of the scanner from the image/object. To achieve a high quality image, it is recommended that you position your scanner 4-6" (10.2-15.2 cm) away from the image/object you are capturing.*

Step 1 - Take a Picture Using IMGSNP

Image Snap - IMGSNP

An image is taken whenever the hardware trigger is pressed, or when the Image Snap (IMGSNP) command is processed.

The image snap command has many different modifiers that can be used to change the look of the image in memory. Any number of modifiers may be appended to the IMGSNP command.

Example: You can use the following command to snap an image, increase the gain, and have the beeper sound once the snap is complete: **IMGSNP2G1B**

IMGSNP Modifiers

P - Imaging Style

This sets the Image Snap style.

- 0P **Decoding Style.** This processing allows a few frames to be taken until the exposure parameters are met. The last frame is then available for further use.
- 1P **Photo Style (default).** This mimics a simple digital camera, and results in a visually optimized image.
- 2P **Manual Style.** This is an advanced style that should only be used by an experienced user. It allows you the most freedom to set up the scanner, and has no auto-exposure.

B - Beeper

Causes a beep to sound after an image is snapped.

- 0B No beep (*default*)
- 1B Sounds a beep when the image is captured.

T - Wait for Trigger

Waits for a hardware trigger press before taking the image. This is only available when using Photo Style (1P).

- 0T Takes image immediately (*default*)
- 1T Waits for a trigger press, then takes the image

L - LED State

Determines if the LEDs should be on or off, and when. Ambient illumination (0L) is preferred for taking pictures of color documents, such as ID cards, especially when the scanner is in a stand. LED illumination (1L) is preferred when the scanner is handheld. LED State is not available when using Decoding Style (0P).

- 0L LEDs off (*default*)
- 1L LEDs on

E - Exposure

Exposure is used in Manual Style only (2P), and allows you to set the exposure time. This is similar to setting a shutter speed on a camera. The exposure time determines how long the scanner takes to record an image. On a bright day, exposure times can be very short because plenty of light is available to help record an image. At nighttime, exposure time can increase dramatically due to the near absence of light. Units are 127 microseconds. (*Default = 7874*)

- nE Range: 1 - 7874

Example: Exposure at 7874E with fluorescent lighting:

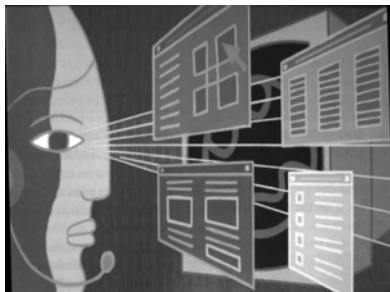

Example: Exposure at 100E with fluorescent lighting:



G - Gain

Gain is used in Manual Style only (2P). Like a volume control, the gain modifier boosts the signal and multiplies the pixel value. As you increase the gain, the noise in an image is also amplified.

1G No gain (*default*)

2G Medium gain

4G Heavy gain

8G Maximum gain

Example:

Gain at 1G:



Gain at 4G:



Gain at 8G:



W - Target White Value

Sets the target for the median grayscale value in the captured image. For capturing close-up images of high contrast documents, a lower setting, such as 75, is recommended. Higher settings result in longer exposure times and brighter images, but if the setting is too high, the image may be overexposed. Target White Value is only available when using Photo Style (1P). (*Default = 125*)

nW Range: 0 - 255

Example:

White Value at 75W:



White Value at 125W:



White Value at 200W:



D - Delta for Acceptance

This sets the allowable range for the white value setting ([see W - Target White Value](#)). Delta is only available when using Photo Style (1P). (*Default = 25*)

nD Range: 0 - 255

U - Update Tries

This sets the maximum number of frames the scanner should take to reach the [D - Delta for Acceptance](#). Update Tries is only available when using Photo Style (1P). (Default = 6)

nU Range: 0 - 10

% - Target Set Point Percentage

Sets the target point for the light and dark values in the captured image. A setting of 75% means 75% of the pixels are at or below the target white value, and 25% of the pixels are above the target white value. Altering this setting from the default is not recommended under normal circumstances. To alter grayscale values, [W - Target White Value](#) should be used. (Default = 50)

n% Range: 1 - 99

Example:

Target Set Point Percentage at 97%:

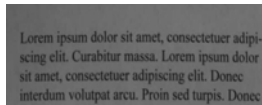

Lorem ipsum dolor sit amet, consectetur adipiscing elit. Curabitur massa. Lorem ipsum dolor sit amet, consectetur adipiscing elit. Donec interdum volutpat arcu. Proin sed turpis. Donec

Target Set Point Percentage at 50%:

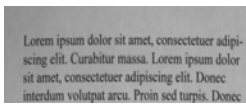

Lorem ipsum dolor sit amet, consectetur adipiscing elit. Curabitur massa. Lorem ipsum dolor sit amet, consectetur adipiscing elit. Donec interdum volutpat arcu. Proin sed turpis. Donec

Target Set Point Percentage at 40%:

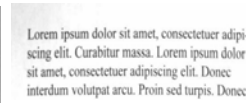

Lorem ipsum dolor sit amet, consectetur adipiscing elit. Curabitur massa. Lorem ipsum dolor sit amet, consectetur adipiscing elit. Donec interdum volutpat arcu. Proin sed turpis. Donec

Step 2 - Ship a Picture Using IMGSHIP

Image Ship - IMGSHIP

An image is taken whenever the trigger is pressed or when the Image Snap (IMGSNP) command is processed. The last image is always stored in memory. You can “ship” the image by using the IMGSHIP command.

The image ship commands have many different modifiers that can be used to change the look of the image output. Modifiers affect the image that is transmitted, but do not affect the image in memory. Any number of modifiers may be appended to the IMGSHIP command.

Example: You can use the following command to snap and ship a bitmap image with gamma correction and document image filtering: IMGSNP;IMGSHIP8F75K26U

IMGSHHP Modifiers

A - Infinity Filter

Enhances pictures taken from very long distances (greater than 10 feet or 3m). The Infinity Filter should not be used with [IMGSNP Modifiers](#) (page 158).

0A Infinity filter off (*default*)

1A Infinity filter on

Example:

Infinity Filter off (0A)
from approximately 12 feet
(3.66m) away:

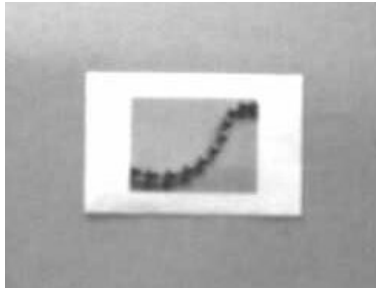

Infinity Filter on (1A)
from approximately 12 feet (3.66m)
away:

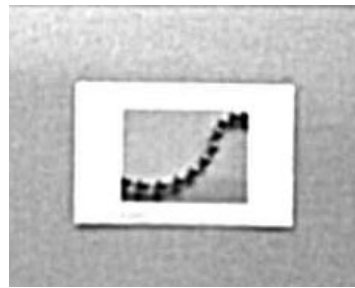

C - Compensation

Flattens the image to account for variations in illumination across the image.

0C Compensation disabled (*default*)

1C Compensation enabled

Example:

Compensation at 0C:



Compensation at 1C:



D - Pixel Depth

Indicates the number of bits per pixel in the transmitted image (KIM or BMP format only).

8D 8 bits per pixel, grayscale image (*default*)

1D 1 bit per pixel, black and white image

E - Edge Sharpen

An edge sharpen filter cleans up the edges of an image, making it look cleaner and sharper. While edge sharpening does make the image look cleaner, it also removes some fine detail from the original image. The strength of the edge sharpen filter can be entered from 1 to 24. Entering a **23E** gives the sharpest edges, but also increases noise in the image.

0E Don't sharpen image (*default*)

14E Apply edge sharpen for typical image

ne Apply edge sharpen using strength *n* ($n = 1-24$)

Example:

Edge Sharpen at 0E:



Edge Sharpen at 24E:



F - File Format

Indicates the desired format for the image.

- 0F KIM format
- 1F TIFF binary
- 2F TIFF binary group 4, compressed
- 3F TIFF grayscale
- 4F Uncompressed binary (upper left to lower right, 1 pixel/bit, 0 padded end of line)
- 5F Uncompressed grayscale (upper left to lower right, bitmap format)
- 6F JPEG image (*default*)
- 8F BMP format (lower right to upper left, uncompressed)
- 10F TIFF color compressed image
- 11F TIFF color uncompressed image
- 12F JPEG color image
- 14F BMP color format
- 15F BMP Uncompressed raw image

H - Histogram Stretch

Increases the contrast of the transmitted image. Not available with some image formats.

- 0H No stretch (*default*)
- 1H Histogram stretch

Example:

Histogram Stretch at 0H:



Histogram Stretch at 1H:



I - Invert Image

Invert image is used to rotate the image around the X or Y axis.

1ix Invert around the X axis (flips picture upside down)

1iy Invert around the Y axis (flips picture left to right)

Example:

Image not inverted:



Image with Invert Image set to 1ix:



Image with Invert Image set to 1iy:



IF- Noise Reduction

Used to reduce the salt and pepper noise in an image.

0if No salt and pepper noise reduction (default)

1if Salt and pepper noise reduction

Example:

Noise Reduction Off (0if):



Noise Reduction On (1if):



IR - Image Rotate

0ir Image as snapped (rightside up) (default)

1ir Rotate image 90 degrees to the right

2ir Rotate image 180 degrees (upside down)

3ir Rotate image 90 degrees to the left

Example:

Image Rotate set to 0ir:



Image Rotate set to 2ir:



Image Rotate set to 1ir:



Image Rotate set to 3ir:



J - JPEG Image Quality

Sets the desired quality when the JPEG image format is selected. Higher numbers result in higher quality, but larger files. Smaller numbers result in greater amounts of lossy compression, faster transmission times, lower quality, but smaller files. (Default = 50)

*n*J Image is compressed as much as possible while preserving quality factor of *n* (*n* = 0 - 100)

0J worst quality (smallest file)

100J best quality (largest file)

K - Gamma Correction

Gamma measures the brightness of midtone values produced by the image. You can brighten or darken an image using gamma correction. A higher gamma correction yields an overall brighter image. The lower the setting, the darker the image. The optimal setting for text images is 50K.

- OK Gamma correction off (*default*)
- 50K Apply gamma correction for brightening typical document image
- nK Apply gamma correction factor n ($n = 0-1,000$)

Example:

Gamma Correction set to 0K:



Gamma Correction set to 50K:



Gamma Correction set to 255K:



L, R, T, B, M - Image Cropping

Ships a window of the image by specifying the left, right, top, and bottom pixel coordinates. Device columns are numbered 0 through 1279, and device rows are numbered 0 through 959.

- nL The left edge of the shipped image corresponds to column n of the image in memory. Range: 000 - 843. (*Default = 0*)
- nR The right edge of the shipped image corresponds to column $n - 1$ of the image in memory. Range: 000 - 843. (*Default = all columns*)
- nT The top edge of the shipped image corresponds to row n of the image in memory. Range: 000 - 639. (*Default = 0*)

nB The bottom edge of the shipped image corresponds to row $n - 1$ of the image in memory. Range: 000 - 639. (*Default = all rows*)

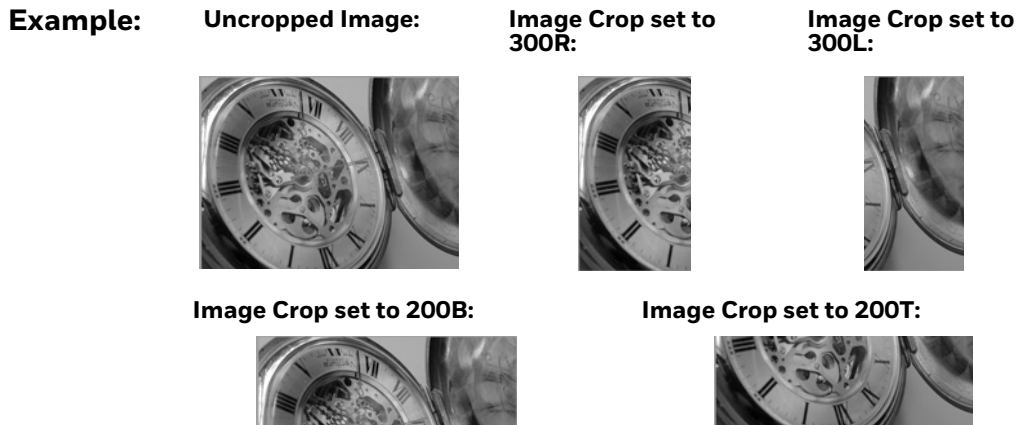

Alternately, specify the number of pixels to cut from the outside margin of the image; thus only the center pixels are transmitted.

nM Margin: cut n columns from the left, $n + 1$ columns from the right, n rows from the top, and $n + 1$ rows from the bottom of the image. Ship the remaining center pixels. Range: 0 - 238. (*Default = 0, or full image*)

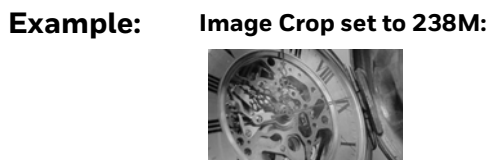

P - Protocol

Used for shipping an image. Protocol covers two features of the image data being sent to the host. It addresses the protocol used to send the data (Hmodem, which is an Xmodem 1K variant that has additional header information), and the format of the image data that is sent.

- 0P None (raw data)
- 2P None (*default for USB*)
- 3P Hmodem compressed (*default for RS232*)
- 4P Hmodem

S - Pixel Ship

Pixel Ship sizes an image in proportion to its original size. It decimates the image by shipping only certain, regularly spaced pixels.

Example: 4S would transmit every fourth pixel from every fourth line.

The smaller number of pixels shipped, the smaller the image, however, after a certain point the image becomes unusable.

- 1S ship every pixel (*default*)
- 2S ship every 2nd pixel, both horizontally and vertically
- 3S ship every 3rd pixel, both horizontally and vertically

Example:

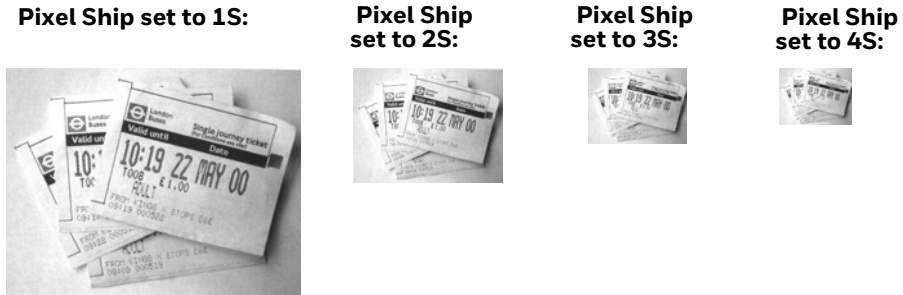

U - Document Image Filter

Allows you to input parameters to sharpen the edges and smooth the area between the edges of text in an image. This filter should be used with gamma correction (see [page 167](#)), with the scanner in a stand, and the image captured using the command:

IMGSNP1POL168W90%32D

This filter typically provides better JPEG compression than the standard E - Edge Sharpen command (see [page 170](#)). This filter also works well when shipping pure black and white images (1 bit per pixel). The optimal setting is 26U.

- 0U Document image filter off (*default*)
- 26U Apply document image filter for typical document image
- nU Apply document image filter using grayscale threshold n. Use lower numbers when the image contrast is lower. 1U will have a similar effect to setting [E - Edge Sharpen](#) (page 163) to 22e. Range: 0-255.

Example:

Document Image Filter set to 0U: Document Image Filter set to 26U:



V - Blur Image

Smooths transitions by averaging the pixels next to the hard edges of defined lines and shaded areas in an image.

0V Don't blur (*default*)

1V Blur

Example:

Blur Image Off (0V):



Blur Image On (1V):



W - Histogram Ship

A histogram gives a quick picture of the tonal range of an image, or key type. A low-key image has detail concentrated in the shadows; a high-key image has detail concentrated in the highlights; and an average-key image has detail concentrated in the midtones. This modifier ships the histogram for an image.

0W Don't ship histogram (*default*)

1W Ship histogram

Example:

Image used for histogram:



Histogram of image:



Image Size Compatibility

If you have applications that expect an image ship to return exactly 640x480 pixels, scan the Force VGA Resolution bar code. *Default = Native Resolution.*



IMGVGA1.

Force VGA Resolution



* Native Resolution

Intelligent Signature Capture - IMGBOX

IMGBOX allows you to configure the size and location of a signature capture area relative to its proximity to a bar code. This allows you to tailor a signature capture area to a specific form. In order to use IMGBOX, you need a set form where the signature box location is in a known location relative to a bar code. You can input the overall size of the signature area, as well as specify how far the signature area is from the bar code, vertically and horizontally. You can also set the resolution and file format for the final output of the signature capture image.

Note: *IMGBOX commands can only be triggered by one of the following types of bar codes: PDF417, Code 39, Code 128, Aztec, Codabar, and Interleaved 2 of 5. Once one of these symbologies has been read, the image is retained for a possible IMGBOX command.*

Signature Capture Optimize

If you will be using your scanner to capture signatures frequently, you should optimize it for this purpose. However, the speed of scanning bar codes may be slowed when this mode is enabled. *Default = Off.*



DECBND1.
Optimize On



DECBND0.
*** Optimize Off**

Below is an example of a signature capture application. In this example, the aimer is centered over the signature capture area and the trigger is pressed. A single beep is emitted, indicating that the scanner has read a Code 128 bar code and the data has been transferred to the host. If using a Granit scanner, the scanner also vibrates. An IMGBOX command may now be sent from the host to specify the coordinates of the signature capture area below that code, and indicating that only that area containing the signature should be transferred as an image to the host.

To see this example, align the aimer with the signature area (not with the bar code), then press the trigger.



Send the following IMGBOX command string after the trigger press:

Example: IMGBOX245w37h55y.

Note: Case is not important in the command string. It is used here only for clarity.

The following image is captured:



The IMGBOX commands have many different modifiers that can be used to change the size and appearance of the signature image output by the scanner. Modifiers affect the image that is transmitted, but do not affect the image in memory. Any number of modifiers may be appended to the IMGBOX command.

Note: The IMGBOX command will return a NAK unless a window size (width and height) are specified. See [H - Height of Signature Capture Area](#) (page 174) and [W - Width of Signature Capture Area](#) (page 175).

IMGBOX Modifiers

A - Output Image Width

This option is used to size the image horizontally. If using this option, set the resolution (R) to zero.

Example: Image Width set to 200A:

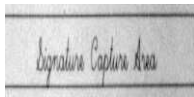
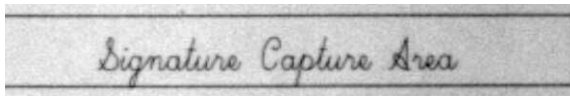

Image Width set to 600A:



B - Output Image Height

This option is used to size the image vertically. If using this option, set the resolution (R) to zero.

Example:

Image Height set to 50B:

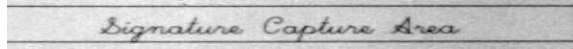
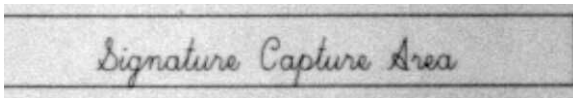

Image Height set to 100B:



D - Pixel Depth

This indicates the number of bits per pixel in the transmitted image, which defines whether it will be grayscale or black and white.

- 8D 8 bits per pixel, grayscale image (*default*)
- 1D 1 bit per pixel, black and white image

F - File Format

This option indicates the type of file format in which to save the image.

- 0F KIM format
- 1F TIFF binary
- 2F TIFF binary group 4, compressed
- 3F TIFF grayscale
- 4F Uncompressed Binary
- 5F Uncompressed grayscale
- 6F JPEG image (*default*)
- 7F Outlined image
- 8F BMP format

H - Height of Signature Capture Area

The height of the signature capture area must be measured in inches divided by .01. In the example, the height of the area to be captured is 3/8 inch, resulting in a value of $H = .375/0.01 = 37.5$.

Example: *IMGBOX245w37h55y*.

K - Gamma Correction

Gamma measures the brightness of midtone values produced by the image. You can brighten or darken an image using gamma correction. A higher gamma correction yields an overall brighter image. The lower the setting, the darker the image. The optimal setting for text images is 50K.

- OK Gamma correction off (*default*)
- 50K Apply gamma correction for brightening typical document image
- nK Apply gamma correction factor n ($n = 1-255$)

Example:

Gamma Correction set to OK:



Gamma Correction set to 50K:



Gamma Correction set to 255K:

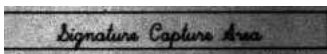

R - Resolution of Signature Capture Area

The resolution is the number of pixels that the scanner outputs per each minimum bar width. The higher the value for R, the higher the quality of the image, but also the larger the file size. Values begin at 1000. The scanner automatically inserts a

decimal point between the first and second digit. For example, use 2500 to specify a resolution of 2.5. Set to zero when using the A and B modifiers (see [A - Output Image Width](#) and [B - Output Image Height](#) on page 173).

Example:

Resolution set to 0R:

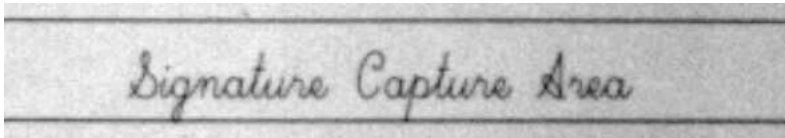

Resolution set to 1000R:

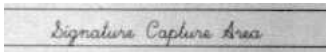

Resolution set to 2000R:

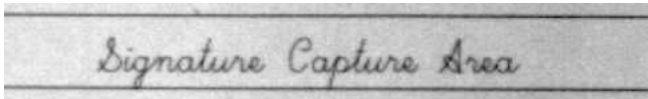

S - Bar Code Aspect Ratio

All dimensions used in IMGBOX are measured as multiples of the minimum element size of the bar code. The bar code aspect ratio allows you to set the ratio of the bar code height to the narrow element width. In the example, the narrow element width is .010 inches and the bar code height is 0.400 inches, resulting in a value of $S = 0.4/0.01 = 40$.

W - Width of Signature Capture Area

The width of the signature capture area must be measured in inches divided by .01. In the example, the width of the area to be captured is 2.4 inches, resulting in a value of $W = 2.4/0.01 = 240$. (A value of 245 was used in the example to accommodate a slightly wider image area.)

Example: `IMGBOX245w37h55y`.

X - Horizontal Bar Code Offset

The horizontal bar code offset allows you to offset the horizontal center of the signature capture area. Positive values move the horizontal center to the right and negative values to the left. Measurements are in multiples of the minimum bar width.

Example:

Horizontal Offset set to 75X:



Horizontal Offset set to -75X:

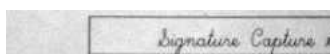

Y - Vertical Bar Code Offset

The vertical bar code offset allows you to offset the vertical center of the signature capture area. Negative numbers indicate that the signature capture is above the bar code, and positive numbers indicate that the area is below the bar code. Measurements are in multiples of the minimum bar width

Vertical Offset set to -7Y:



Vertical Offset set to 65Y:

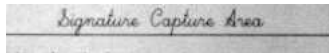

Add a Test Code I.D. Prefix to All Symbologies

This selection allows you to turn on transmission of a Code I.D. before the decoded symbology. (See the [Symbology Charts](#), beginning on page 221) for the single character code that identifies each symbology.) This action first clears all current prefixes, then programs a Code I.D. prefix for all symbologies. This is a temporary setting that will be removed when the unit is power cycled.



PRECA2,BK2995C80!

**Add Code I.D. Prefix to
All Symbologies (Temporary)**

Show Decoder Revision

Scan the bar code below to output the decoder revision.



REV_DR.

Show Decoder Revision

Show Scan Driver Revision

Scan the bar code below to output the scan driver revision. The scan driver controls image capture.



REV_SD.

Show Scan Driver Revision

Show Software Revision

Scan the bar code below to output the current software revision, unit serial number, and other product information for both the scanner.



REVINF.

Show Revision

Show Data Format

Scan the bar code below to show current data format settings.



DFMBK3?.

Data Format Settings

Test Menu

When you scan the Test Menu **On** code, then scan a programming code in this manual, the scanner displays the content of a programming code. The programming function will still occur, but in addition, the content of that programming code is output to the terminal.

Note: *This feature should not be used during normal scanner operation.*



TSTMNU1.

On



TSTMNU0.

*** Off**

TotalFreedom

TotalFreedom is an open system architecture that makes it possible for you create applications that reside on your scanner. Decoding apps and Data Formatting apps can be created using TotalFreedom. For further information about TotalFreedom, go to our website at www.honeywellaidc.com.

Application Plug-Ins (Apps)

Any apps that you are using can be turned off or on by scanning the following bar codes. Apps are stored in groups: Decoding, and Formatting. You can enable and disable these groups of apps by scanning that group's **On** or **Off** bar code below. You can also scan the **List Apps** bar code to output a list of all your apps.



PLGDCE1.
* Decoding Apps On



PLGDCE0.
Decoding Apps Off



PLGFOE1.
* Formatting Apps On



PLGFOE0.
Formatting Apps Off



PLGINF.
List Apps

Note: You must reset your device in order for the apps setting to take effect.

EZConfig Cloud for Scanning Introduction

EZConfig Cloud for Scanning provides a wide range of PC-based programming functions that can be performed on a scanner connected to your PC. EZConfig Cloud for Scanning allows you to download upgrades to the scanner's firmware, change programmed parameters, and create and print programming bar codes. Using EZConfig Cloud for Scanning, you can even save/open the programming parameters for a scanner. This saved file can be e-mailed or, if required, you can create a single bar code that contains all the customized programming parameters and mail or fax that bar code to any location. Users in other locations can scan the bar code to load in the customized programming.

EZConfig Cloud for Scanning Operations

The EZConfig Cloud for Scanning software performs the following operations:

Scan Data

Scan Data allows you to scan bar codes and display the bar code data in a window. Scan Data lets you send serial commands to the scanner and receive scanner response that can be seen in the Scan Data window. The data displayed in the Scan Data window can either be saved in a file or printed.

Configure

Configure displays the programming and configuration data of the scanner. The scanner's programming and configuration data is grouped into different categories. Each category is displayed as a tree item under the "Configure" tree node in the application explorer. When one of these tree nodes is clicked, the right-hand side is loaded with the parameters' form belonging to that particular category. The "Configure" tree option has all the programming and configuration parameters specified for a scanner. You can set or modify these parameters as required. You can later write the modified settings to the scanner, or save them to a dcf file.

Imaging

Imaging provides all the image-related functions that a 2D Scanner can perform. You can capture an image using the current settings, and the image will be displayed in an image window. Images captured from the scanner can be saved to files in different image formats. You can modify the image settings and save the image settings to an INI file, which can be loaded later to capture new images. Imaging also lets you preview the images continuously captured by the scanner.

Install EZConfig Cloud for Scanning

Use the EZConfig Cloud for Scanning tool to configure your scanner online:

1. Access the Honeywell web site at www.honeywellaidc.com
2. Click on the **Browse Products** tab. Under **Software**, select **Device Management**.
3. Click on **EZConfig Cloud for Scanning**.
4. Scroll to the bottom of the page and click on **Register for free access now** to sign up.

Reset the Factory Defaults



Caution: *This selection erases all your settings and resets the scanner to the original factory defaults. It also disables all plugins.*

If you aren't sure what programming options are in your scanner, or you've changed some options and want to restore the scanner to factory default settings, first scan the **Remove Custom Defaults** bar code, then scan **Activate Defaults**. This resets the scanner to the factory default settings.



DEFOVR.

Remove Custom Defaults



DEFAULT.

Activate Defaults

The [Menu Commands](#), beginning on page 187 list the factory default settings for each of the commands (indicated by an asterisk (*) on the programming pages).

SERIAL PROGRAMMING COMMANDS

The serial programming commands can be used in place of the programming bar codes. Both the serial commands and the programming bar codes will program the scanner. For complete descriptions and examples of each serial programming command, refer to the corresponding programming bar code in this manual.

The device must be set to an RS232 interface (see [page 14](#)). The following commands can be sent via a PC COM port using terminal emulation software.

Conventions

The following conventions are used for menu and query command descriptions:

<i>parameter</i>	A label representing the actual value you should send as part of a command.
[<i>option</i>]	An optional part of a command.
{Data}	Alternatives in a command.
bold	Names of menus, menu commands, buttons, dialog boxes, and windows that appear on the screen.

Menu Command Syntax

Menu commands have the following syntax (spaces have been used for clarity only):

Prefix [*:Name:*] *Tag SubTag {Data}* [, *SubTag {Data}*] [*; Tag SubTag {Data}*] [...] *Storage*

Prefix Three ASCII characters: SYN M CR (ASCII 22,77,13).

:Name: To send information to the scanner (with the base connected to host), use :Solaris: The default factory setting for a Solaris scanner is Solaris scanner. This setting is changed by using the BT_NAM command, which accepts alphanumeric values. If the name is not known, a wildcard (*) can be used :*

Tag	A 3 character case-insensitive field that identifies the desired menu command group. For example, all RS232 configuration settings are identified with a Tag of 232 .
SubTag	A 3 character case-insensitive field that identifies the desired menu command within the tag group. For example, the SubTag for the RS232 baud rate is BAD .
Data	The new value for a menu setting, identified by the Tag and SubTag.
Storage	A single character that specifies the storage table to which the command is applied. An exclamation point (!) performs the command's operation on the device's volatile menu configuration table. A period (.) performs the command's operation on the device's non-volatile menu configuration table. Use the non-volatile table only for semi-permanent changes you want saved through a power cycle.

Query Commands

Several special characters can be used to query the device about its settings.

- ^ What is the default value for the setting(s).
- ? What is the device's current value for the setting(s).
- * What is the range of possible values for the setting(s). (The device's response uses a dash (-) to indicate a continuous range of values. A pipe (|) separates items in a list of non-continuous values.)

:Name: Field Usage (Optional)

This command returns the query information from the scanner.

Tag Field Usage

When a query is used in place of a Tag field, the query applies to the *entire* set of commands available for the particular storage table indicated by the Storage field of the command. In this case, the SubTag and Data fields should not be used because they are ignored by the device.

SubTag Field Usage

When a query is used in place of a SubTag field, the query applies only to the subset of commands available that match the Tag field. In this case, the Data field should not be used because it is ignored by the device.

Data Field Usage

When a query is used in place of the Data field, the query applies only to the specific command identified by the Tag and SubTag fields.

Concatenation of Multiple Commands

Multiple commands can be issued within one Prefix/Storage sequence. Only the Tag, SubTag, and Data fields must be repeated for each command in the sequence. If additional commands are to be applied to the same Tag, then the new command sequence is separated with a comma (,) and only the SubTag and Data fields of the additional command are issued. If the additional command requires a different Tag field, the command is separated from previous commands by a semicolon (;).

Responses

The device responds to serial commands with one of three responses:

- ACK** Indicates a good command which has been processed.
- ENQ** Indicates an invalid Tag or SubTag command.
- NAK** Indicates the command was good, but the Data field entry was out of the allowable range for this Tag and SubTag combination, e.g., an entry for a minimum message length of 100 when the field will only accept 2 characters.

When responding, the device echoes back the command sequence with the status character inserted directly before each of the punctuation marks (the period, exclamation point, comma, or semicolon) in the command.

Examples of Query Commands

In the following examples, a bracketed notation [] depicts a non-displayable response.

Example: What is the range of possible values for Codabar Coding Enable?

Enter: **cbrena*.**

Response: **CBRENA0-1[ACK]**

This response indicates that Codabar Coding Enable (CBRENA) has a range of values from 0 to 1 (off and on).

Example: What is the default value for Codabar Coding Enable?

Enter: **cbrena^.**

Response: **CBRENA1[ACK]**

This response indicates that the default setting for Codabar Coding Enable (CBRENA) is 1, or on.

Example: What is the device's current setting for Codabar Coding Enable?

Enter: **cbrena?.**

Response: **CBRENA1[ACK]**

This response indicates that the device's Codabar Coding Enable (CBRENA) is set to 1, or on.

Example: What are the device's settings for all Codabar selections?

Enter: **cbr?.**

Response: **CBRENA1[ACK],
SSX0[ACK],
CK20[ACK],
CCT1[ACK],
MIN2[ACK],
MAX60[ACK],
DFT[ACK].**

This response indicates that the device's Codabar Coding Enable (CBRENA) is set to 1, or on;
the Start/Stop Character (SSX) is set to 0, or Don't Transmit;
the Check Character (CK2) is set to 0, or Not Required;
concatenation (CCT) is set to 1, or Enabled;
the Minimum Message Length (MIN) is set to 2 characters;
the Maximum Message Length (MAX) is set to 60 characters;
and the Default setting (DFT) has no value.

Trigger Commands

You can activate and deactivate the scanner with serial trigger commands. First, the scanner must be put in Manual Trigger Mode by scanning a Manual Trigger Mode bar code ([page 41](#)), or by sending a serial menu command for triggering ([page 41](#)). Once the scanner is in serial trigger mode, the trigger is activated and deactivated by sending the following commands:

Activate: **SYN T CR**

Deactivate: **SYN U CR**

The scanner scans until a bar code has been read, until the deactivate command is sent, or until the serial time-out has been reached (see "Read Time-Out" on [page 3-41](#) for a description, and the serial command on [page 192](#)).

Resetting the Custom Defaults

If you want the custom default settings restored to your scanner, scan the **Activate Custom Defaults** bar code below. This resets the scanner to the custom default settings. If there are no custom defaults, it will reset the scanner to the factory default settings. Any settings that have not been specified through the custom defaults will be defaulted to the factory default settings.



Activate Custom Defaults

The charts on the following pages list the factory default settings for each of the commands (indicated by an asterisk (*) on the programming pages).

Menu Commands

Selection	Setting * Indicates default	Serial Command # Indicates a numeric entry	Page
Product Default Settings			
Beeper Volume Adjustment	Volume Adjustment Off	BTNVOLO	10
	*Volume Adjustment On	BTNVOL1	10
Beeper Frequency Adjustment	Frequency Adjustment Off	BTNTONO	11
	*Frequency Adjustment On	BTNTON1	11
Setting Custom Defaults	Set Custom Defaults	MNUCDP	12
	Save Custom Defaults	MNUCDS	12
Resetting the Custom Defaults	Activate Custom Defaults	DEFAULT	12
Program the Interface			
Plug and Play Codes	Keyboard Wedge: IBM PC AT and Compatibles with CR suffix	PAP_AT	13
	Laptop Direct Connect with CR suffix	PAPLTD	14
	RS232 Serial Port	PAP232	14
Plug and Play Codes: RS485	IBM Port 5B Interface	PAPP5B	14
	IBM Port 9B HHBCR-1 Interface	PAP9B1	14
	IBM Port 17 Interface	PAPP17	14
	IBM Port 9B HHBCR-2 Interface	PAP9B2	15
	RS485 Packet Mode On	RTLPDF1	15
	RS485 Packet Mode Off	RTLPDF0	15
	RS485 Packet Length (20-256)	RTLMPS	16

Selection	Setting * Indicates default	Serial Command # Indicates a numeric entry	Page
Plug and Play Codes: IBM SurePos	USB IBM SurePos Handheld	PAPSPH	16
	USB IBM SurePos Tabletop	PAPSPT	16
Plug and Play Codes: USB	USB Keyboard (PC)	PAP124	16
	USB Keyboard (Mac)	PAP125	17
	USB Japanese Keyboard (PC)	TRMUSB134	17
	USB HID	PAP131	17
	USB Serial	TRMUSB130	17
	CTS/RTS Emulation On	USBCTS1	17
	CTS/RTS Emulation Off*	USBCTS0	17
	ACK/NAK Mode On	USBACK1	18
	ACK/NAK Mode Off*	USBACK0	18
Plug and Play Codes	Verifone Ruby Terminal	PAPRBY	18
	Gilbarco Terminal	PAPGLB	18
	Wincor Nixdorf Terminal	PAPWNX	19
	Wincor Nixdorf Beetle	PAPBTL	19
	Wincor Nixdorf RS232 Mode A	PAPWMA	
Program Keyboard Country	*U.S.A.	KBDCTY0	20
	Albania	KBDCTY35	20
	Azeri (Cyrillic)	KBDCTY81	20
	Azeri (Latin)	KBDCTY80	20
	Belarus	KBDCTY82	20
	Belgium	KBDCTY1	20
	Bosnia	KBDCTY33	20
	Brazil	KBDCTY16	20
	Brazil (MS)	KBDCTY59	21
	Bulgaria (Cyrillic)	KBDCTY52	21
	Bulgaria (Latin)	KBDCTY53	21
	Canada (French legacy)	KBDCTY54	21
	Canada (French)	KBDCTY18	21
	Canada (Multilingual)	KBDCTY55	21
	Croatia	KBDCTY32	21
	Czech	KBDCTY15	21
	Czech (Programmers)	KBDCTY40	21
	Czech (QWERTY)	KBDCTY39	21
	Czech (QWERTZ)	KBDCTY38	21
	Denmark	KBDCTY8	21
Dutch (Netherlands)	KBDCTY11	22	

Selection	Setting * Indicates default	Serial Command # Indicates a numeric entry	Page
	Estonia	KBDCTY41	22
	Faroese	KBDCTY83	22
	Finland	KBDCTY2	22
	France	KBDCTY3	22
	Gaelic	KBDCTY84	22
	Germany	KBDCTY4	22
	Greek	KBDCTY17	22
	Greek (220 Latin)	KBDCTY64	22
	Greek (220)	KBDCTY61	22
	Greek (319 Latin)	KBDCTY65	22
	Greek (319)	KBDCTY62	22
	Greek (Latin)	KBDCTY63	23
	Greek (MS)	KBDCTY66	23
	Greek (Polytonic)	KBDCTY60	23
	Hebrew	KBDCTY12	23
	Hungarian (101 key)	KBDCTY50	23
	Hungary	KBDCTY19	23
	Iceland	KBDCTY75	23
	Irish	KBDCTY73	23
	Italian (142)	KBDCTY56	23
	Italy	KBDCTY5	23
	Japan ASCII	KBDCTY28	23
	Kazakh	KBDCTY78	23
	Kyrgyz (Cyrillic)	KBDCTY79	24
	Latin America	KBDCTY14	24
	Latvia	KBDCTY42	24
	Latvia (QWERTY)	KBDCTY43	24
	Lithuania	KBDCTY44	24
	Lithuania (IBM)	KBDCTY45	24
	Macedonia	KBDCTY34	24
	Malta	KBDCTY74	24
	Mongolian (Cyrillic)	KBDCTY86	24
	Norway	KBDCTY9	24
	Poland	KBDCTY20	24
	Polish (214)	KBDCTY57	24
	Polish (Programmers)	KBDCTY58	25
	Portugal	KBDCTY13	25

Selection	Setting * Indicates default	Serial Command # Indicates a numeric entry	Page
	Romania	KBDCTY25	25
	Russia	KBDCTY26	25
	Russian (MS)	KBDCTY67	25
	Russian (Typewriter)	KBDCTY68	25
	SCS	KBDCTY21	25
	Serbia (Cyrillic)	KBDCTY37	25
	Serbia (Latin)	KBDCTY36	25
	Slovakia	KBDCTY22	25
	Slovakia (QWERTY)	KBDCTY49	25
	Slovakia (QWERTZ)	KBDCTY48	25
	Slovenia	KBDCTY31	26
	Spain	KBDCTY10	26
	Spanish variation	KBDCTY51	26
	Sweden	KBDCTY23	26
	Switzerland (French)	KBDCTY29	26
	Switzerland (German)	KBDCTY6	26
	Tatar	KBDCTY85	26
	Turkey F	KBDCTY27	26
	Turkey Q	KBDCTY24	26
	Ukrainian	KBDCTY76	26
	United Kingdom	KBDCTY7	26
	United Stated (Dvorak right)	KBDCTY89	27
	United States (Dvorak left)	KBDCTY88	27
	United States (Dvorak)	KBDCTY87	26
	United States (International)	KBDCTY30	27
	Uzbek (Cyrillic)	KBDCTY77	27
Keyboard Conversion	*Keyboard Conversion Off	KBDCNV0	28
	Convert all Characters to Upper Case	KBDCNV1	29
	Convert all Characters to Lower Case	KBDCNV2	29
Keyboard Style	*Regular	KBDSTY0	27
	Caps Lock	KBDSTY1	27
	Shift Lock	KBDSTY2	27
	Automatic Caps Lock	KBDSTY6	28
	Emulate External Keyboard	KBDSTY5	28
Control Character Output	*Control Character Output Off	KBDNPE0	29
	*Control Character Output On	KBDNPE1	29
Keyboard Modifiers	*Control + X Off	KBDCAS0	30

Selection	Setting * Indicates default	Serial Command # Indicates a numeric entry	Page
	DOS Mode Control + X	KBDCAS1	30
	Windows Mode Control + X	KBDCAS2	30
	Windows Mode Prefix/Suffix Off	KBDCAS3	30
	*Turbo Mode Off	KBDTMD0	30
	Turbo Mode On	KBDTMD1	30
	*Numeric Keypad Off	KBDNPS0	30
	Numeric Keypad On	KBDNPS1	30
	*Auto Direct Connect Off	KBDADC0	31
	Auto Direct Connect On	KBDADC1	30
Baud Rate	300 BPS	232BAD0	31
	600 BPS	232BAD1	31
	1200 BPS	232BAD2	31
	2400 BPS	232BAD3	31
	4800 BPS	232BAD4	31
	9600 BPS	232BAD5	32
	19200 BPS	232BAD6	31
	38400 BPS	232BAD7	31
	57600 BPS	232BAD8	32
	*115200 BPS	232BAD9	32
Word Length: Data Bits, Stop Bits, and Parity	7 Data, 1 Stop, Parity Even	232WRD3	32
	7 Data, 1 Stop, Parity None	232WRD0	32
	7 Data, 1 Stop, Parity Odd	232WRD6	32
	7 Data, 2 Stop, Parity Even	232WRD4	32
	7 Data, 2 Stop, Parity None	232WRD1	32
	7 Data, 2 Stop, Parity Odd	232WRD7	32
	8 Data, 1 Stop, Parity Even	232WRD5	32
	*8 Data, 1 Stop, Parity None	232WRD2	33
	8 Data, 1 Stop, Parity Odd	232WRD8	33
	8 Data, 1 Stop, Parity Mark	232WRD14	33
RS232 Receiver Time-out	Range 0 - 300 seconds	232LPT###	33
RS232 Handshaking	*RTS/CTS Off	232CTS0	34
	Flow Control, No Timeout	232CTS1	33
	Two-Direction Flow Control	232CTS2	34
	Flow Control with Timeout	232CTS3	34
	RS232 Timeout	232DEL####	34
	*XON/XOFF Off	232XON0	34
	XON/XOFF On	232XON1	34

Selection	Setting * Indicates default	Serial Command # Indicates a numeric entry	Page
	*ACK/NAK Off	232ACK0	35
	ACK/NAK On	232ACK1	35
Input/Output Selections			
Power Up Beeper	Power Up Beeper Off - Scanner	BEPWRO	37
	*Power Up Beeper On - Scanner	BEPWR1	37
Beep on BEL Character	Beep on BEL On	BELBEP1	37
	*Beep on BEL Off	BELBEP0	37
Beeper - Good Read	Off	BEPBEP0	38
	*On	BEPBEP1	38
Beeper Volume - Good Read	Off	BEPLVL0	38
	Low	BEPLVL1	38
	Medium	BEPLVL2	38
	*High	BEPLVL3	38
Beeper Pitch - Good Read (Frequency)	*Low (870) (min 400Hz)	BEPFQ1870	38
	Medium (1140 Hz)	BEPFQ11140	38
	High (1800) (max 9000Hz)	BEPFQ11800	38
Beeper Pitch - Error (Frequency)	*Razz (250) (min 200Hz)	BEPFQ2800	39
	Medium (3250)	BEPFQ23250	39
	High (4200) (max 9000Hz)	BEPFQ24200	39
Beeper Duration - Good Read	*Normal Beep	BEPBIPO	39
	Short Beep	BEPBIP1	39
LED - Good Read	Off	BEPLED0	40
	*On	BEPLED1	40
Number of Beeps - Error	*5	BEPERR3	40
	Range 1 - 9	BEPERR#	40
Number of Beeps - Good Read	*1	BEPRPT1	40
	Range 1 - 9	BEPRPT#	40
Beeper Volume Max	Beeper Volume Max	PAPBLM	40
Good Read Delay	*No Delay	DLYGRD0	41
	Short Delay (500 ms)	DLYGRD500	41
	Medium Delay (1000 ms)	DLYGRD1000	41
	Long Delay (1500 ms)	DLYGRD1500	41
User-Specified Good Read Delay	Range 0 - 30,000 ms	DLYGRD#####	41
Serial Trigger Mode	Read Time-Out (0 - 300,000 ms) *30,000	TRGSTO#####	41
Presentation Mode	*Presentation Mode	TRGMOD3	42

Selection	Setting * Indicates default	Serial Command # Indicates a numeric entry	Page
Presentation Idle Mode	Presentation Idle Mode (0-3,000,000) *10,000 (10s)	TRGPMT###	42
	Off	TRGPMT0	42
Presentation Sleep Mode	*On	TRGTSI1	43
	Off	TRGTSIO	43
	Timeout (0-3,600,000) *300,000 (300s)	TRGTST	43
LED Illumination - Presentation Mode	Off	PWRLDC0	44
	Low	PWRLDC100	44
	*High	PWRLDC150	44
Presentation LED Behavior After Decode	*LEDs On	TRGPCK1	44
	LEDs Off	TRGPCK0	44
Presentation Sensitivity	Range 0-20 (*1)	TRGPMS##	45
Presentation Centering Window	Presentation Centering On	PDCWIN1	46
	*Presentation Centering Off	PDCWIN0	46
	Left of Presentation Centering Window (*40%)	PDCLFT###	47
	Right of Presentation Centering Window (*60%)	PDCRGT###	47
	Top of Presentation Centering Window (*40%)	PDCTOP###	46
	Bottom of Presentation Centering Window (*60%)	PDCBOT###	47
Streaming Presentation	Streaming Presentation Mode - Normal	PAPSPN	47
	Streaming Presentation Mode - Enhanced	PAPSPE	47
Mobile Phone Read Mode	Presentation - Mobile Phone	PAPPSC	47
Poor Quality PDF Codes	Poor Quality PDF Reading On	PDFXPR1	48
	*Poor Quality PDF Reading Off	PDFXPR0	48
Poor Quality Code Enhanced Mode	Poor Quality Code Enhanced Mode	PAPPSP	48
Reread Delay	*Short (500 ms)	DLYRRD500	48
	Medium (750 ms)	DLYRRD750	48
	Long (1000 ms)	DLYRRD1000	49
	Extra Long (2000 ms)	DLYRRD2000	48
User-Specified	Range 0 - 30,000 ms	DLYRRD#####	49
Illumination Lights	*Lights On	SCNLED1	49
	Lights Off	SCNLED0	49
Centering Window	Centering On	DECWIN1	50
	*Centering Off	DECWIN0	50
	Left of Centering Window (*40%)	DECLFT###	51
	Right of Centering Window (*60%)	DECRGT###	51

Selection	Setting * Indicates default	Serial Command # Indicates a numeric entry	Page
	Top of Centering Window (*40%)	DECTOP###	51
	Bottom of Centering Window (*60%)	DECBOT###	51
Preferred Symbology	On	PRFENA1	51
	*Off	PRFENA0	52
	High Priority Symbology	PRFCOD##	52
	Low Priority Symbology	PRFBLK##	52
	Preferred Symbology Timeout (*500) Range 100-3000	PRFPTO####	52
	Preferred Symbology Default	PRFDFT	53
Character Activation Mode	*Off	HSTCEN0	53
	On	HSTCEN1	53
	Activation Character	HSTACH##	53
	Do Not End Character Activation After Good Read	HSTCGD0	53
	End Character Activation After Good Read	HSTCGD1	53
	Character Activation Led Timeout (Range 1 - 65535) *5000 ms	HSTCDT#####	54
Character Deactivation Mode	*Off	HSTDEN0	54
	On	HSTDEN1	54
	Deactivation Character	HSTDCH##	54
Output Sequence Editor	Enter Sequence	SEQBLK	59
	*Discard Partial Sequence	SEQTTS0	61
	Default Sequence	SEQDFT	61
Require Output Sequence	Required	SEQ_EN2	61
	On/Not Required	SEQ_EN1	61
	*Off	SEQ_EN0	61
No Read	On	SHWNRD1	62
	*Off	SHWNRD0	62
Video Reverse	Video Reverse Only	VIDREV1	62
	Video Reverse and Standard Bar Codes	VIDREV2	62
	*Video Reverse Off	VIDREVO	63
Working Orientation	*Upright	ROTATN0	63
	Vertical, Bottom to Top (Rotate CCW 90°)	ROTATN1	63
	Upside Down	ROTATN2	63
	Vertical, Top to Bottom (Rotate CW 90°)	ROTATN3	63
Prefix/Suffix Selections			
Add CR Suffix to All Symbologies		VSUF CR	67

Selection	Setting * Indicates default	Serial Command # Indicates a numeric entry	Page
Prefix	Add Prefix	PREBK2##	67
	Clear One Prefix	PRECL2	67
	Clear All Prefixes	PRECA2	67
Suffix	Add Suffix	SUFBK2##	67
	Clear One Suffix	SUFCL2	67
	Clear All Suffixes	SUFCA2	67
Function Code Transmit	*Enable	RMVFNC0	68
	Disable	RMVFNC1	68
Intercharacter Delay	Range 0 - 1000 (5ms increments)	DLYCHR##	69
User Specified Intercharacter Delay	Delay Length 0 - 1000 (5ms increments)	DLYCRX##	69
	Character to Trigger Delay	DLY_XX##	69
Interfunction Delay	Range 0 - 1000 (5ms increments)	DLYFNC##	70
Intermessage Delay	Range 0 - 1000 (5ms increments)	DLYMSG##	70
Data Format Selections			
Data Format Editor	*Default Data Format (None)	DFMDF3	72
	Enter Data Format	DFMBK3##	73
	Clear One Data Format	DFMCL3	73
	Clear All Data Formats	DFMCA3	73
Data Formatter	Data Formatter Off	DFM_EN0	86
	*Data Formatter On, Not Required, Keep Prefix/Suffix	DFM_EN1	87
	Data Format Required, Keep Prefix/Suffix	DFM_EN2	87
	Data Formatter On, Not Required, Drop Prefix/Suffix	DFM_EN3	87
	Data Format Required, Drop Prefix/Suffix	DFM_EN4	87
Data Format Non-Match Error Tone	*Data Format Non-Match Error Tone On	DFMDEC0	88
	Data Format Non-Match Error Tone Off	DFMDEC1	88
Primary/Alternate Data Formats	Primary Data Format	ALTFNM0	88
	Data Format 1	ALTFNM1	88
	Data Format 2	ALTFNM2	88
	Data Format 3	ALTFNM3	88
Single Scan Data Format Change	Single Scan-Primary Data Format	VSAF_0	89
	Single Scan-Data Format 1	VSAF_1	89

Selection	Setting * Indicates default	Serial Command # Indicates a numeric entry	Page
	Single Scan-Data Format 2	VSAF_2	89
	Single Scan-Data Format 3	VSAF_3	89
Symbologies			
All Symbologies	All Symbologies Off	ALLENA0	92
Codabar	Default All Codabar Settings	CBRDFT	92
	*On	CBRENA1	92
	Off	CBRENA0	93
Codabar Start/Stop Char.	*Don't Transmit	CBRSSX0	93
	Transmit	CBRSSX1	93
Codabar Check Char.	*No Check Char.	CBRCK20	93
	Validate, But Don't Transmit	CBRCK21	93
	Validate, and Transmit	CBRCK22	94
Codabar Concatenation	*Off	CBRCCT0	94
	On	CBRCCT1	94
	Require	CBRCCT2	94
Codabar Redundancy	Range (0 - 10) *0	CBRVOT##	94
Codabar Message Length	Minimum (2 - 60) *4	CBRMIN##	95
	Maximum (2 - 60) *60	CBRMAX##	95
Code 39	Default All Code 39 Settings	C39DFT	95
	Off	C39ENA0	95
	*On	C39ENA1	95
Code 39 Start/Stop Char.	*Don't Transmit	C39SSX0	96
	Transmit	C39SSX1	95
Code 39 Check Char.	*No Check Char.	C39CK20	96
	Validate, But Don't Transmit	C39CK21	96
	Validate, and Transmit	C39CK22	96
Code 39 Message Length	Minimum (0 - 48) *0	C39MIN##	96
	Maximum (0 - 48) *48	C39MAX##	96
Code 39 Append	*Off	C39APP0	97
	On	C39APP1	97
Code 39 Redundancy	Range (0 - 10) *0	C39VOT##	97
Code 32 Pharmaceutical (PARAF)	*Off	C39B320	97
	On	C39B321	97

Selection	Setting * Indicates default	Serial Command # Indicates a numeric entry	Page
Code 39 Full ASCII	*Off	C39ASC0	98
	On	C39ASC1	98
	Code 39 Code Page	C39DCP	99
Interleaved 2 of 5	Default All Interleaved 2 of 5 Settings	I25DFT	99
	Off	I25ENAO	99
	*On	I25ENA1	99
Interleaved 2 of 5 Check Digit	*No Check Char.	I25CK20	99
	Validate, But Don't Transmit	I25CK21	100
	Validate, and Transmit	I25CK22	100
Interleaved 2 of 5 Redundancy	Range (0 - 10) *0	I25VOT##	100
Interleaved 2 of 5 Message Length	Minimum (2 - 80) *4	I25MIN##	100
	Maximum (2 - 80) *80	I25MAX##	100
NEC 2 of 5	Default All NEC 2 of 5 Settings	N25DFT	100
	Off	N25ENAO	101
	*On	N25ENA1	101
NEC 2 of 5 Check Digit	*No Check Char.	N25CK20	101
	Validate, But Don't Transmit	N25CK21	101
	Validate, and Transmit	N25CK22	101
NEC 2 of 5 Message Length	Minimum (2 - 80) *4	N25MIN##	101
	Maximum (2 - 80) *80	N25MAX##	102
Code 93	Default All Code 93 Settings	C93DFT	102
	Off	C93ENAO	102
	*On	C93ENA1	103
Code 93 Message Length	Minimum (0 - 80) *0	C93MIN##	102
	Maximum (0 - 80) *80	C93MAX##	102
Code 93 Append	On	C93APP1	103
	*Off	C93APP0	103
Code 93 Code Page	Code 93 Code Page	C93DCP	103
Straight 2 of 5 Industrial	Default All Straight 2 of 5 Industrial Settings	R25DFT	103
	*Off	R25ENAO	103
	On	R25ENA1	103
Straight 2 of 5 Industrial Message Length	Minimum (1 - 48) *4	R25MIN##	104
	Maximum (1 - 48) *48	R25MAX##	104

Selection	Setting * Indicates default	Serial Command # Indicates a numeric entry	Page
Straight 2 of 5 IATA	Default All Straight 2 of 5 IATA Settings	A25DFT	104
	*Off	A25ENAO	104
	On	A25ENA1	104
Straight 2 of 5 IATA Redundancy	Range (0 - 10) *0	A25VOT##	104
Straight 2 of 5 IATA Message Length	Minimum (1 - 48) *4	A25MIN##	105
	Maximum (1 - 48) *48	A25MAX##	105
Matrix 2 of 5	Default All Matrix 2 of 5 Settings	X25DFT	105
	*Off	X25ENAO	105
	On	X25ENA1	105
Matrix 2 of 5 Message Length	Minimum (1 - 80) *4	X25MIN##	106
	Maximum (1 - 80) *80	X25MAX##	106
Code 11	Default All Code 11 Settings	C11DFT	106
	*Off	C11ENAO	106
	On	C11ENA1	106
Code 11 Check Digits Required	1 Check Digit	C11CK20	106
	*2 Check Digits	C11CK21	107
Code 11 Message Length	Minimum (1 - 80) *4	C11MIN##	107
	Maximum (1 - 80) *80	C11MAX##	107
Code 128	Default All Code 128 Settings	128DFT	107
	Off	128ENAO	107
	*On	128ENA1	107
ISBT 128 Concatenation	*Off	ISBENAO	108
	On	ISBENA1	108
Code 128 Redundancy	Range (0 - 10) *0	128VOT##	108
Code 128 Message Length	Minimum (0 - 80) *0	128MIN##	108
	Maximum (0 - 80) *80	128MAX##	108
Code 128 Append	*On	128APP1	108
	Off	128APP0	109
Code 128 Code Page	Code 128 Code Page (*2)	128DCP##	109
GS1-128	Default All GS1-128 Settings	GS1DFT	109
	*On	GS1ENA1	109
	Off	GS1ENAO	110
GS1-128 Message Length	Minimum (1 - 80) *1	GS1MIN##	110
	Maximum (0 - 80) *80	GS1MAX##	110

Selection	Setting * Indicates default	Serial Command # Indicates a numeric entry	Page
Telepen	Default All Telepen Settings	TELDFT	110
	*Off	TELENA0	110
	On	TELENA1	110
Telepen Output	*AIM Telepen Output	TELOLD0	111
	Original Telepen Output	TELOLD1	111
Telepen Message Length	Minimum (1 - 60) *1	TELMIN##	111
	Maximum (1 - 60) *60	TELMAX##	111
UPC-A	Default All UPC-A Settings	UPADFT	111
	Off	UPBENA0	112
	*On	UPBENA1	112
UPC-A Check Digit	Off	UPACKX0	112
	*On	UPACKX1	112
UPC-A Number System	Off	UPANSX0	112
	*On	UPANSX1	112
UPC-A 2 Digit Addenda	*Off	UPAAD20	113
	On	UPAAD21	113
UPC-A 5 Digit Addenda	*Off	UPAAD50	113
	On	UPAAD51	113
UPC-A Addenda Required	*Not Required	UPAARQ0	113
	Required	UPAARQ1	113
Addenda Timeout	Range (0 - 120) *500	DLYADD###	114
UPC-A Addenda Separator	Off	UPAADS0	114
	*On	UPAADS1	114
UPC-A/EAN-13 with Extended Coupon Code	*Off	CPNENA0	114
	Allow Concatenation	CPNENA1	114
	Require Concatenation	CPNENA2	115
Coupon GS1 DataBar Output	GS1 Output Off	CPNGS10	115
	GS1 Output On	CPNGS11	115
UPC-E0	Default All UPC-E Settings	UPEDFT	115
	Off	UPEEN00	115
	*On	UPEEN01	115
UPC-E0 Expand	*Off	UPEEXP0	116
	On	UPEEXP1	116
UPC-E0 Addenda Required	Required	UPEARQ1	116
	*Not Required	UPEARQ0	116
Addenda Timeout	Range (0 - 120) *500	DLYADD###	116

Selection	Setting * Indicates default	Serial Command # Indicates a numeric entry	Page
UPC-E0 Addenda Separator	*On	UPEADS1	117
	Off	UPEADS0	117
UPC-E0 Check Digit	Off	UPECKX0	117
	*On	UPECKX1	117
UPC-E0 Leading Zero	Off	UPENSX0	117
	*On	UPENSX1	117
UPC-E0 Addenda	2 Digit Addenda On	UPEAD21	118
	*2 Digit Addenda Off	UPEAD20	118
	5 Digit Addenda On	UPEAD51	118
	*5 Digit Addenda Off	UPEAD50	118
UPC-E1	*Off	UPEEN10	118
	On	UPEEN11	118
EAN/JAN-13	Default All EAN/JAN Settings	E13DFT	118
	Off	E13ENA0	119
	*On	E13ENA1	119
Convert UPC-A to EAN-13	UPC-A Converted to EAN-13	UPAENA0	119
	Do not Convert UPC-A	UPAENA1	119
EAN/JAN-13 Check Digit	Off	E13CKX0	119
	*On	E13CKX1	119
EAN/JAN-13 2 Digit Addenda	2 Digit Addenda On	E13AD21	120
	*2 Digit Addenda Off	E13AD20	120
	5 Digit Addenda On	E13AD51	120
	*5 Digit Addenda Off	E13AD50	120
EAN/JAN-13 Addenda Required	*Not Required	E13ARQ0	120
	Required	E13ARQ1	120
EAN-13 Beginning with 290 Addenda Required	* Don't Require 5 Digit Addenda	ARQ2900	121
	Require 5 Digit Addenda	ARQ2901	121
EAN-13 Beginning with 378/379 Addenda Required	*Don't Require Addenda	ARQ3780	121
	Require 2 Digit Addenda	ARQ3781	121
	Require 5 Digit Addenda	ARQ3782	121
	Require 2 or 5 Digit Addenda	ARQ3783	121
EAN-13 Beginning with 414/419 Addenda Required	*Don't Require Addenda	ARQ4140	122
	Require 2 Digit Addenda	ARQ4141	122
	Require 5 Digit Addenda	ARQ4142	122
	Require 2 or 5 Digit Addenda	ARQ4143	122

Selection	Setting * Indicates default	Serial Command # Indicates a numeric entry	Page
EAN-13 Beginning with 977 Addenda Required	*Don't Require 2 Digit Addenda	ARQ9770	123
	Require 2 Digit Addenda	ARQ9771	122
EAN-13 Beginning with 978 Addenda Required	*Don't Require 5 Digit Addenda	ARQ9780	123
	Require 5 Digit Addenda	ARQ9781	123
EAN-13 Beginning with 979 Addenda Required	*Don't Require 5 Digit Addenda	ARQ9790	124
	Require 5 Digit Addenda	ARQ9791	124
Addenda Timeout	Range (0 - 120) *500	DLYADD###	124
EAN/JAN-13 Addenda Separator	Off	E13ADS0	124
	*On	E13ADS1	124
ISBN Translate	*Off	E13ISB0	125
	On	E13ISB1	125
EAN/JAN-8	Default All EAN/JAN 8 Settings	EA8DFT	125
	Off	EA8ENA0	125
	*On	EA8ENA1	125
EAN/JAN-8 Check Digit	Off	EA8CKX0	125
	*On	EA8CKX1	125
EAN/JAN-8 Addenda	*2 Digit Addenda Off	EA8AD20	126
	2 Digit Addenda On	EA8AD21	126
	*5 Digit Addenda Off	EA8AD50	126
	5 Digit Addenda On	EA8AD51	126
EAN/JAN-8 Addenda Required	*Not Required	EA8ARQ0	126
	Required	EA8ARQ1	126
Addenda Timeout	Range (0 - 120) *500	DLYADD###	127
EAN/JAN-8 Addenda Separator	Off	EA8ADS0	127
	*On	EA8ADS1	127
MSI	Default All MSI Settings	MSIDFT	127
	*Off	MSIENA0	127
	On	MSIENA1	127
MSI Check Character	*Validate Type 10, but Don't Transmit	MSICHK0	128
	Validate Type 10 and Transmit	MSICHK1	128
	Validate 2 Type 10 Chars, but Don't Transmit	MSICHK2	128
	Validate 2 Type 10 Chars and Transmit	MSICHK3	128
	Validate Type 11 then Type 10 Char, but Don't Transmit	MSICHK4	128
	Validate Type 11 then Type 10 Char and Transmit	MSICHK5	128
	Disable MSI Check Characters	MSICHK6	128

Selection	Setting * Indicates default	Serial Command # Indicates a numeric entry	Page
MSI Message Length	Minimum (4 - 48) *4	MSIMIN##	129
	Maximum (4 - 48) *48	MSIMAX##	129
GS1 DataBar Omnidirectional	Default All GS1 DataBar Omnidirectional Settings	RSSDFT	129
	Off	RSSENA0	129
	*On	RSSENA1	129
GS1 DataBar Limited	Default All GS1 DataBar Limited Settings	RSLDFT	129
	Off	RSLENA0	130
	*On	RSLENA1	130
GS1 DataBar Expanded	Default All GS1 DataBar Expanded Settings	RSEDFT	130
	Off	RSEENA0	130
	*On	RSEENA1	130
GS1 DataBar Expanded Msg. Length	Minimum (4 - 74) *4	RSEMIN##	130
	Maximum (4 - 74) *74	RSEMAX##	130
Trioptic Code	*Off	TRIENA0	131
	On	TRIENA1	131
Codablock A	Default All Codablock A Settings	CBADFT	131
	*Off	CBAENA0	131
	On	CBAENA1	131
Codablock A Msg. Length	Minimum (1 - 600) *1	CBAMIN###	132
	Maximum (1 - 600) *600	CBAMAX###	132
Codablock F	Default All Codablock F Settings	CBFDFT	131
	*Off	CBFENA0	132
	On	CBFENA1	132
Codablock F Msg. Length	Minimum (1 - 2048) *1	CBFMIN####	132
	Maximum (1 - 2048) *2048	CBFMAX####	133
Label Code	On	LBLENA1	133
	* Off	LBLENA0	133
PDF417	Default All PDF417 Settings	PDFDFT	133
	*On	PDFENA1	133
	Off	PDFENA0	133
PDF417 Msg. Length	Minimum (1-2750) *1	PDFMIN####	134
	Maximum (1-2750) *2750	PDFMAX####	134
MacroPDF417	*On	PDFMAC1	134
	Off	PDFMAC0	134

Selection	Setting * Indicates default	Serial Command # Indicates a numeric entry	Page
MicroPDF417	Default All Micro PDF417 Settings	MPDDFT	134
	On	MPDENA1	135
	*Off	MPDENA0	135
MicroPDF417 Msg. Length	Minimum (1-366) *1	MPDMIN###	135
	Maximum (1-366) *366	MPDMAX###	135
GS1 Composite Codes	On	COMENA1	135
	*Off	COMENA0	135
UPC/EAN Version	On	COMUPC1	136
	*Off	COMUPC0	136
GS1 Composite Codes Msg. Length	Minimum (1-2435) *1	COMMINS###	136
	Maximum (1-2435) *2435	COMMINS###	136
GS1 Emulation	GS1-128 Emulation	EANEMU1	137
	GS1 DataBar Emulation	EANEMU2	137
	GS1 Code Expansion Off	EANEMU3	137
	EAN8 to EAN13 Conversion	EANEMU4	137
	*GS1 Emulation Off	EANEMU0	137
TCIF Linked Code 39	On	T39ENA1	137
	*Off	T39ENA0	137
QR Code	Default All QR Code Settings	QRCDFT	143
	*On	QRCENA1	138
	Off	QRCENA0	138
QR Code Msg. Length	Minimum (1-7089) *1	QRCMIN###	138
	Maximum (1-7089) *7089	QRCMAX###	138
QR Code Append	*One Scan	QRCAPP1	138
	Swipe	QRCAPP2	138
	Point and Shoot	QRCAPP3	138
	Off	QRCAPP0	138
QR Code Page	QR Code Page (*3)	QRCDCP##	139
Data Matrix	Default All Data Matrix Settings	IDMDFT	139
	*On	IDMENA1	140
	Off	IDMENA0	140
Data Matrix Msg. Length	Minimum (1-3116) *1	IDMMIN###	140
	Maximum (1-3116) *3116	IDMMAX###	140
Data Matrix Append	*On	IDMAPP1	140
	Off	IDMAPP0	140
Data Matrix Code Page	Data Matrix Code Page (*51)	IDMDCP##	141

Selection	Setting * Indicates default	Serial Command # Indicates a numeric entry	Page
MaxiCode	Default All MaxiCode Settings	MAXDFT	141
	On	MAXENA1	141
	*Off	MAXENA0	141
MaxiCode Msg. Length	Minimum (1-150) *1	MAXMIN###	141
	Maximum (1-150) *150	MAXMAX###	141
Aztec Code	Default All Aztec Code Settings	AZTDFT	142
	*On	AZTENA1	142
	Off	AZTENA0	142
Aztec Code Msg. Length	Minimum (1-3832) *1	AZTMIN####	142
	Maximum (1-3832) *3832	AZTMAX####	142
Aztec Append	*On	AZTAPP1	142
	Off	AZTAPP0	143
Aztec Code Page	Aztec Code Page (*51)	AZTDCP##	143
Chinese Sensible (Han Xin) Code	Default All Han Xin Code Settings	HX_DFT	143
	On	HX_ENA1	143
	*Off	HX_ENA0	143
Chinese Sensible (Han Xin) Code Msg. Length	Minimum (1-7833) *1	HX_MIN####	144
	Maximum (1-7833) *7833	HX_MAX####	144
Postal Codes - 2D			
2D Postal Codes	*Off	POSTAL0	144
Single 2D Postal Codes	Australian Post On	POSTAL1	144
	British Post On	POSTAL7	144
	Canadian Post On	POSTAL30	144
	Intelligent Mail Bar Code On	POSTAL10	144
	Japanese Post On	POSTAL3	145
	KIX Post On	POSTAL4	145
	Planet Code On	POSTAL5	145
	Postal-4i On	POSTAL9	145
	Postnet On	POSTAL6	145
	Postnet with B and B' Fields On	POSTAL11	145
	InfoMail On	POSTAL2	145
Combination 2D Postal Codes	InfoMail and British Post On	POSTAL8	145
	Intelligent Mail Bar Code and Postnet with B and B' Fields On	POSTAL20	145
	Postnet and Postal-4i On	POSTAL14	146
	Postnet and Intelligent Mail Bar Code On	POSTAL16	146
	Postal-4i and Intelligent Mail Bar Code On	POSTAL17	146

Selection	Setting * Indicates default	Serial Command # Indicates a numeric entry	Page
	Postal-4i and Postnet with B and B' Fields On	POSTAL19	146
	Planet and Postnet On	POSTAL12	146
	Planet and Postnet with B and B' Fields On	POSTAL18	146
	Planet and Postal-4i On	POSTAL13	146
	Planet and Intelligent Mail Bar Code On	POSTAL15	146
	Planet, Postnet, and Postal-4i On	POSTAL21	146
	Planet, Postnet, and Intelligent Mail Bar Code On	POSTAL22	146
	Planet, Postal-4i, and Intelligent Mail Bar Code On	POSTAL23	147
	Postnet, Postal-4i, and Intelligent Mail Bar Code On	POSTAL24	147
	Planet, Postal-4i, and Postnet with B and B' Fields On	POSTAL25	147
	Planet, Intelligent Mail Bar Code, and Postnet with B and B' Fields On	POSTAL26	147
	Postal-4i, Intelligent Mail Bar Code, and Postnet with B and B' Fields On	POSTAL27	147
	Planet, Postal-4i, Intelligent Mail Bar Code, and Postnet On	POSTAL28	147
	Planet, Postal-4i, Intelligent Mail Bar Code, and Postnet with B and B' Fields On	POSTAL29	147
Planet Code Check Digit	Transmit	PLNCKX1	147
	*Don't Transmit	PLNCKX0	148
Postnet Check Digit	Transmit	NETCKX1	148
	*Don't Transmit	NETCKX0	148
Australian Post Interpretation	Bar Output	AUSINT0	148
	Numeric N Table	AUSINT1	148
	Alphanumeric C Table	AUSINT2	148
	Combination N and C Tables	AUSINT3	149
Postal Codes - Linear			
China Post (Hong Kong 2 of 5)	Default All China Post (Hong Kong 2 of 5) Settings	CPCDFT	149
	*Off	CPCENA0	149
	On	CPCENA1	149
China Post (Hong Kong 2 of 5) Msg. Length	Minimum (2 - 80) *4	CPCMIN##	149
	Maximum (2 - 80) *80	CPCMAX##	149

Selection	Setting * Indicates default	Serial Command # Indicates a numeric entry	Page
Korea Post	Default All Korea Post Settings	KPCDFT	150
	*Off	KPCENA0	150
	On	KPCENA1	150
Korea Post Msg. Length	Minimum (2 - 80) *4	KPCMIN##	150
	Maximum (2 - 80) *48	KPCMAX##	150
Korea Post Check Digit	Transmit Check Digit	KPCCHK1	150
	*Don't Transmit Check Digit	KPCCHK0	150
EAS Settings			
EAS Deactivation Range	On	PDCPP123	151
EAS Controller	*Off	EASTYPO	153
	On	EASTYP1	153
EAS Mode of Operation	*Interlocked	EASMOD0	153
	Continuous on Enable	EASMOD1	154
EAS Interlocked Duration Timeout	EASTIM (1-5000) *100ms	EASTIM#####	154
Imaging Default Commands			
Image Snap	Default all Imaging Commands	IMGDFT	157
	Imaging Style - Decoding	SNPSTY0	158
	*Imaging Style - Photo	SNPSTY1	158
	Imaging Style - Manual	SNPSTY2	158
	Beeper On	SNPBEP1	158
	*Beeper Off	SNPBEP0	158
	*LED State - Off	SNPLED0	159
	LED State - On	SNPLED1	159
	Exposure (1-7874 microseconds)	SNPEXP	159
	*Gain - None	SNPGAN1	160
	Gain - Medium	SNPGAN2	160
	Gain - Heavy	SNPGAN4	160
	Gain - Maximum	SNPGAN8	160
	Target White Value (0-255) *125	SNPWHT###	160
	Delta for Acceptance (0-255) *25	SNPDEL###	160
	Update Tries (0-10) *6	SNPTRY##	161
	Target Set Point Percentage (1-99) *50	SNPPCT##	161
Image Ship	*Infinity Filter - Off	IMGINFO	162
	Infinity Filter - On	IMGINF1	162
	*Compensation Off	IMGCOR0	162
	Compensation On	IMGCOR1	162
	*Pixel Depth - 8 bits/pixel (grayscale)	IMGBPP8	162

Selection	Setting * Indicates default	Serial Command # Indicates a numeric entry	Page
	Pixel Depth - 1 bit/pixel (B&W)	IMGBPP1	162
	*Don't Sharpen Edges	IMGEDG0	163
	Sharpen Edges (0-23)	IMGEDG##	163
	*File Format - JPEG	IMGFMT6	164
	File Format - KIM	IMGFMT0	164
	File Format - TIFF binary	IMGFMT1	164
	File Format - TIFF binary group 4, compressed	IMGFMT2	164
	File Format - TIFF grayscale	IMGFMT3	164
	File Format - Uncompressed binary	IMGFMT4	164
	File Format - Uncompressed grayscale	IMGFMT5	164
	File Format - BMP	IMGFMT8	164
	*Histogram Stretch Off	IMGHIS0	164
	Histogram Stretch On	IMGHIS1	164
	*Noise Reduction Off	IMGFSP0	165
	Noise Reduction On	IMGFSP1	165
	Invert Image around X axis	IMGNVX1	165
	Invert Image around Y axis	IMGNVY1	165
	Rotate Image none	IMGROTO	166
	Rotate Image 90° right	IMGROT1	166
	Rotate Image 180° right	IMGROT2	166
	Rotate Image 90° left	IMGROT3	166
	JPEG Image Quality (0-100) *50	IMGJQF###	166
	*Gamma Correction Off	IMGGAM0	167
	Gamma Correction On (0-1000)	IMGGAM###	167
	Image Crop - Left (0-843) *0	IMGWNL###	167
	Image Crop - Right (0-843) *843	IMGWNR###	167
	Image Crop - Top (0-639) *0	IMGWNT###	167
	Image Crop - Bottom (0-639) *639	IMGWNB###	168
	Image Crop - Margin (1-238) *0	IMGMAR###	168
	Protocol - None (raw)	IMGXFR0	168
	Protocol - None (default USB)	IMGXFR2	168
	Protocol - Hmodem Compressed	IMGXFR3	168
	Protocol - Hmodem	IMGXFR4	168
	Ship Every Pixel	IMGSUB1	169
	Ship Every 2nd Pixel	IMGSUB2	169
	Ship Every 3rd Pixel	IMGSUB3	169
	*Document Image Filter Off	IMGUSH0	169

Selection	Setting * Indicates default	Serial Command # Indicates a numeric entry	Page
	Document Image Filter On (0-255)	IMGUSH###	169
	*Don't Ship Histogram	IMGHST0	170
	Ship Histogram	IMGHST1	170
Image Size Compatibility	Force VGA Resolution	IMGVGA1	170
	*Native Resolution	IMGVGA0	171
Intelligent Signature Capture	Optimize On	DECBND1	171
	*Optimize Off	DECBND0	171
Utilities			
Add Code I.D. Prefix to All Symbologies (Temporary)		PRECA2,BK2995C80!	177
Show Decoder Revision		REV_DR	177
Show Scan Driver Revision		REV_SD	177
Show Software Revision		REVINP	178
Show Data Format		DFMBK3?	178
Test Menu	On	TSTMNU1	178
	*Off	TSTMNU0	178
Application Plug-Ins (Apps)	*Decoding Apps On	PLGDCE1	179
	Decoding Apps Off	PLGDCE0	179
	*Formatting Apps On	PLGFOE1	179
	Formatting Apps Off	PLGFOE0	179
	List Apps	PLGINP	179
Resetting the Factory Defaults	Remove Custom Defaults	DEFOVR	181
	Activate Defaults	DEFALT	181

Solaris 7980g Scanner Product Specifications

Parameter	Specification
Dimensions (Typical):	
Height	5.83 inches (148mm)
Width	5.98 inches (152mm)
Depth	3.34 inches (85mm)
Weight	19 ounces (539g)
Illumination LED:	
Peak Wavelength	2700K CCT (warm white LED)
Image Size	1280 x 960 pixels
Skew Angle	±75°
Pitch Angle	±65°
Motion Tolerance: Presentation Mode	up to 118 inches per second (3.0 m/s) for 13 mil UPC
Symbol Contrast	Grade 1.0 (25% or greater)
Voltage Requirements	5.2 ± 5% VDC at input connector
Current Draw:	
Operation	400mA
Idle	270mA
Sleep	210mA
Power Supply Noise Rejection	Maximum 100mV peak to peak, 10 to 100 kHz
Temperature Ranges:	
Operating	+32°F to +104°F (0°C to 40°C)
Storage	-4°F to +140°F (-20°C to 60°C)
Humidity	5 to 95% non-condensing
Mechanical Drop	Operational after 30 drops from 5 feet (1.5m) to concrete at 23°C

(Continued)Parameter	Specification
Side Impact	5.8J energy after 18 hits
Vibration	Withstands 10G peak from 10 to 500Hz
IP Rating	IP 5X
ESD Tolerance	Up to 15kV direct air Up to 8 kV indirect

Depth of Field Charts

Typical Performance

Focus		Standard Range (SR)	
Symbology		Near Distance	Far Distance
5 mil Code 39	in.	0.4	5.5
	mm	10	140
6.7 mil PDF417	in.	0.8	5.5
	mm	20	140
13 mil UPC-A	in.	0.0	10.6
	mm	0.0	270
20 mil Code 39	in.	0.0	11.8
	mm	0.0	300
20 mil Data Matrix	in.	0.6	7.5
	mm	15	190
20 mil QR	in.	0	7.5
	mm	0	190
Resolution (1D Code 39)		3 mil (.076mm)	
Resolution (2D Data Matrix)		8.3 mil (.211mm)	

Guaranteed Performance

Focus		Standard Range (SR)	
Symbology		Near Distance	Far Distance
5 mil Code 39	in.	0.6	4.7
	mm	15	120
6.7 mil PDF417	in.	1.5	5.1
	mm	38	130
13 mil UPC-A	in.	0.0	9.6
	mm	0.0	245
20 mil Code 39	in.	0.0	10.2
	mm	0.0	260
20 mil Data Matrix	in.	1.1	6.3
	mm	27	160
20 mil QR	in.	0.4	6.7
	mm	10	170
Resolution (1D Code 39)		3 mil (.076mm)	
Resolution (2D Data Matrix)		8.3 mil (.211mm)	

Standard Connector Pinouts

Note: *The following pin assignments are not compatible with Honeywell legacy products. Use of a cable with improper pin assignments may lead to damage to the unit. Use of any cables not provided by the manufacturer may result in damage not covered by your warranty.*

Keyboard Wedge

10 Pin RJ41 Modular Plug

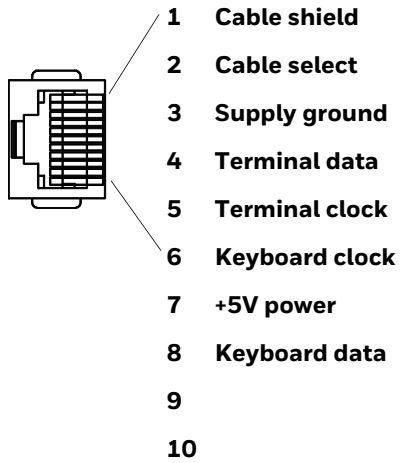

Serial Output

10 Pin RJ41 Modular Plug

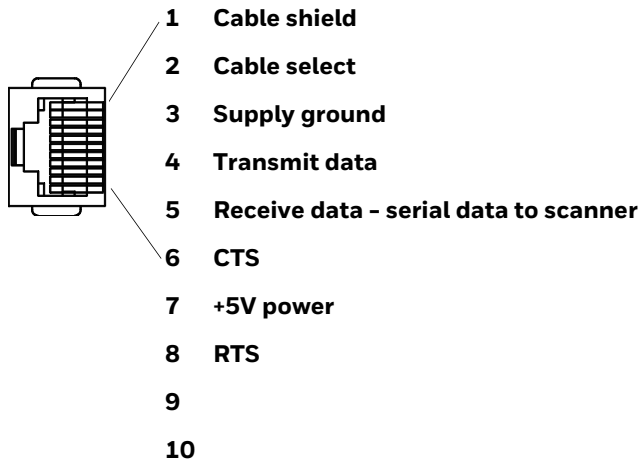

RS485 Output

10 Pin RJ41 Modular Plug

Note: RS485 signal conversion is performed in the cable.

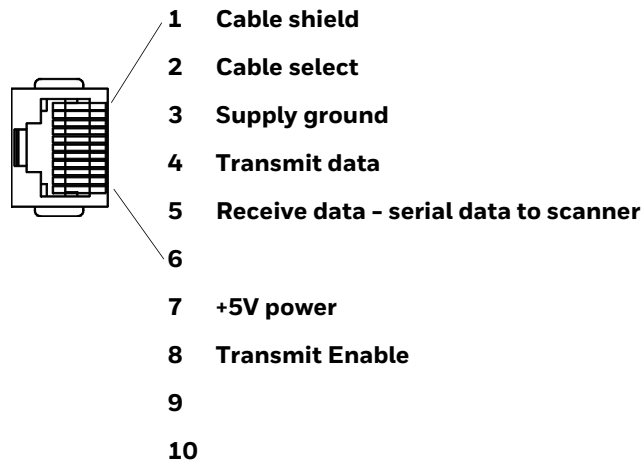

USB

10 Pin Modular Plug

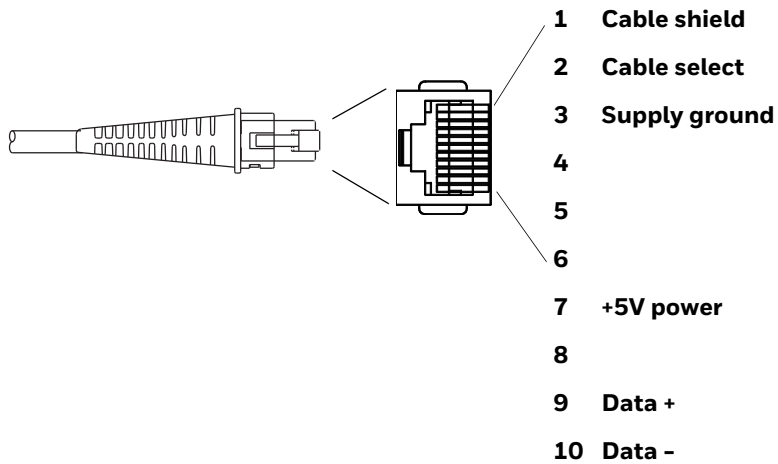

EAS

6 Pin Modular Plug

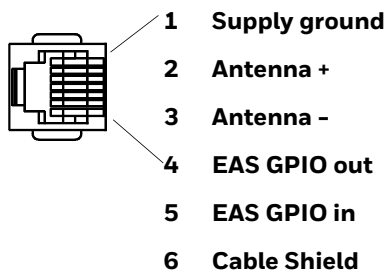

USB Auxiliary Scanner - Solaris end

USB Type A Plug



- 1 VBUS
- 2 D-
- 3 D+
- 4 Ground

Required Safety Labels

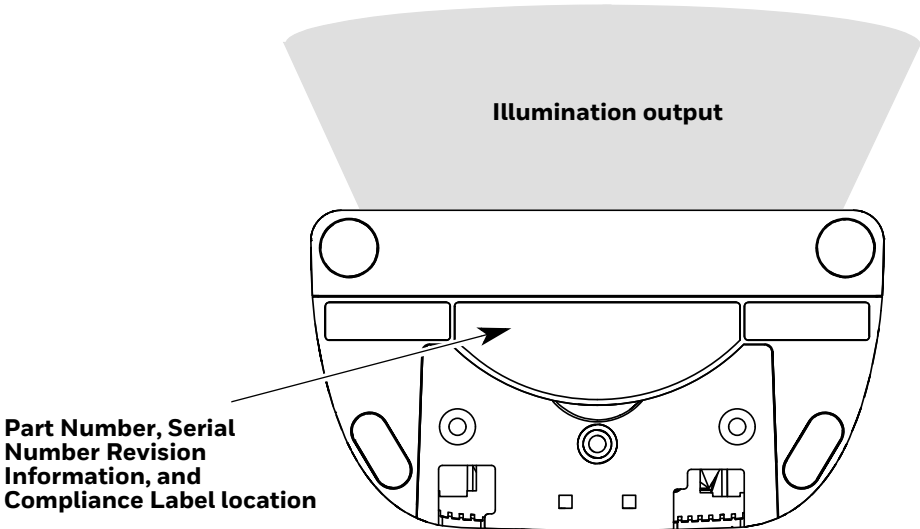

MAINTENANCE AND TROUBLESHOOTING

Repairs

Repairs and/or upgrades are not to be performed on this product. These services are to be performed only by an authorized service center (see [Technical Assistance](#) on page xi).

Maintenance

Your device provides reliable and efficient operation with a minimum of care. Although specific maintenance is not required, the following periodic checks ensure dependable operation:

Cleaning the Scanner

The scanner's housing may be cleaned with a soft cloth or tissue dampened with water (or a mild detergent-water solution.) If a detergent solution is used, rinse with a clean tissue dampened with water only.



Caution: Do not submerge the scanner in water. The scanner's housing is not watertight. Do not use abrasive wipes or tissues on the scanner's window. Abrasive wipes may scratch the window. Never use solvents (e.g., acetone) on the housing or window. Solvents may damage the finish or the window.

Cleaning the Window

Reading performance may degrade if the scanner's window is not clean. If the window is visibly dirty, or if the scanner isn't operating well, clean the window with one of the cleaning solutions listed below.

- Sani-Cloth[®] HB wipes
- Sani-Cloth[®] Plus wipes

- Super Sani-Cloth[®] wipes
- Isopropyl Alcohol wipes (70%)
- CaviWipes[™]
- Virex[®] 256
- 409[®] Glass and Surface Cleaner
- Windex[®] Blue
- Clorox[®] Bleach – 10%
- Gentle dish soap and water

Inspecting Cords and Connectors

Inspect the interface cable and connector for wear or other signs of damage. A badly worn cable or damaged connector may interfere with scanner operation. Contact your distributor for information about cable replacement. Cable replacement instructions are on [page 216](#).

Replacing Cables

The standard interface cable is attached to the scanner with an 10-pin modular connector. When properly seated, the connector is held in the scanner by a flexible retention tab. The interface cable is designed to be field replaceable.

- Order replacement cables from Honeywell or from an authorized distributor.
- When ordering a replacement cable, specify the cable part number of the original interface cable.

Replacing the Interface Cable

1. Turn off the host system power.
2. Disconnect the scanner's cable from the terminal or computer.
3. Remove the scanner's back cover.

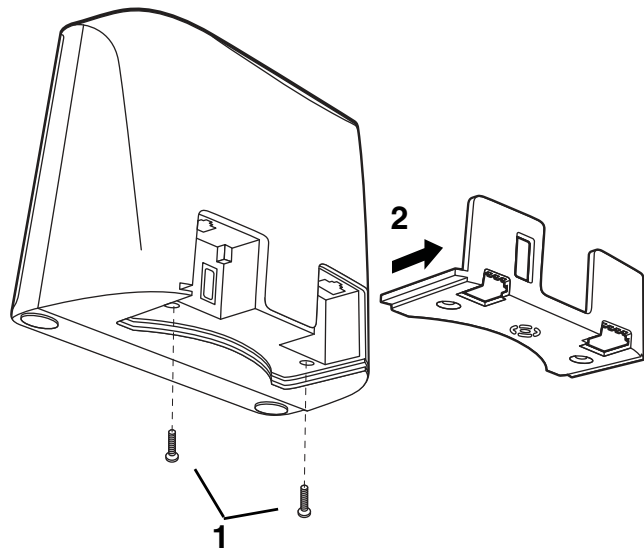

4. Pinch the interface cable jack and gently pull cable from the port. Pull the cable through the back cover.
5. Replace with the new cable.

Replacing an EAS Cable

1. Turn off the host system power.
2. Disconnect the scanner's cable from the terminal or computer.
3. Remove the scanner's back cover.

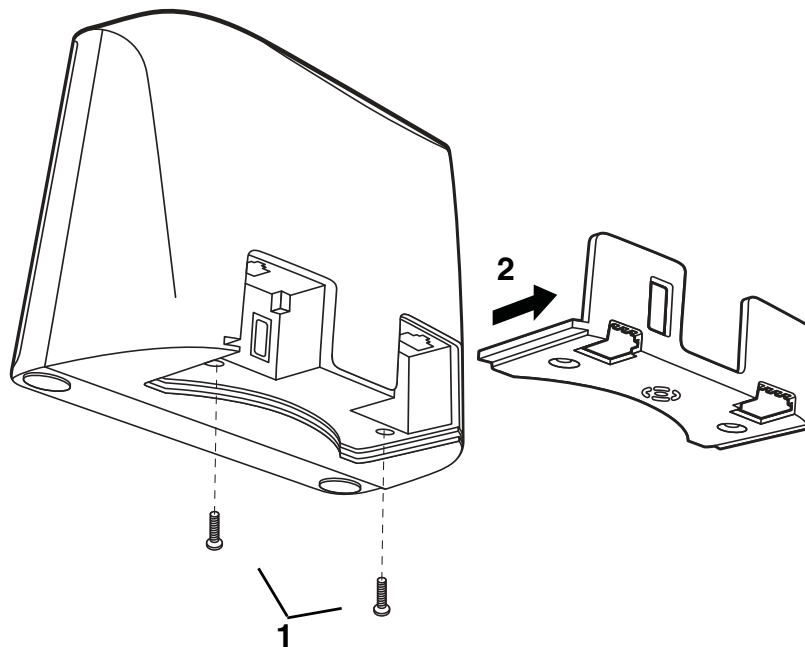

4. Pinch the EAS cable jack and gently pull cable from the port. Pull the cable through the back cover.
5. Follow the steps from [Replacing the Interface Cable](#) (see page 216) to remove the interface cable.
6. Replace with the new EAS cable. Insert the connector into the opening and it will click into place.

Troubleshooting

The scanner automatically performs self-tests whenever you turn it on. If your scanner is not functioning properly, review the following Troubleshooting Guide to try to isolate the problem.

Note: Visit the Services and Support section of our website (www.honeywellaidc.com) to check for the latest scanner software.

Is the power on?

If the LED isn't illuminated, check that:

- The cable is connected properly.
- The host system power is on (if external power isn't used).

Is the scanner having trouble reading your symbols?

If the scanner isn't reading symbols well, check that the symbols:

- Aren't smeared, rough, scratched, or exhibiting voids.
- Aren't coated with frost or water droplets on the surface.
- Are enabled in the scanner or in the decoder to which the scanner connects.

Is the bar code displayed but not entered?

The bar code is displayed on the host device correctly, but you still have to press a key to enter it (the Enter/Return key or the Tab key, for example).

- You need to program a suffix. Programming a suffix enables the scanner to output the bar code data plus the key you need (such as "CR") to enter the data into your application. Refer to [Prefix/Suffix Overview](#) on page 65 for further information.

Does the scanner read the bar code incorrectly?

If the scanner reads a bar code, but the data is not displayed correctly on the host screen:

- The scanner may not be programmed for the appropriate terminal interface. For example, you scan "12345" and the host displays "@es%o."

Reprogram the scanner with the correct Plug and Play bar code. See [Program the Interface](#) beginning on page 13.

- The scanner may not be programmed to output your bar code data properly. For example, you scan “12345” and the host displays “A12345B.”

Reprogram the scanner with the proper symbology selections. See [Chapter 6](#).

The scanner won't read your bar code at all.

- Scan the sample bar codes in the back of this manual. If the scanner reads the sample bar codes, check that your bar code is readable.
- Verify that your bar code symbology is enabled (see [Chapter 6](#)).

If you aren't sure what programming options have been set in the scanner, or if you want the factory default settings restored, refer to [Reset the Factory Defaults](#) on page 180.

REFERENCE CHARTS

Symbology Charts

Note: “m” represents the AIM modifier character. Refer to *International Technical Specification, Symbology Identifiers*, for AIM modifier character details.

Prefix/Suffix entries for specific symbologies override the universal (All Symbologies, 99) entry.

Refer to [Data Edit](#) beginning on page 65 and [Data Format](#) beginning on page 71 for information about using Code ID and AIM ID.

Linear Symbologies

Linear Symbology	AIM		Honeywell	
	ID	Possible modifiers (m)	ID	Hex
All Symbologies				99
Codabar	JFm	0-1	a	61
Code 11	JH3		h	68
Code 128	JCm	0, 1, 2, 4	j	6A
Code 32 Pharmaceutical (PARAF)	JX0		<	3C
Code 39 (supports Full ASCII mode)	JAm	0, 1, 3, 4, 5, 7	b	62
TCIF Linked Code 39 (TLC39)	JL2		T	54
Code 93 and 93i	JGm	0-9, A-Z, a-m	i	69
EAN	JEm	0, 1, 3, 4	d	64
EAN-13 (including Bookland EAN)	JE0		d	64
EAN-13 with Add-On	JE3		d	64
EAN-13 with Extended Coupon Code	JE3		d	64
EAN-8	JE4		D	44
EAN-8 with Add-On	JE3		D	44

Linear Symbology	AIM		Honeywell	
	ID	Possible modifiers (m)	ID	Hex
GS1				
GS1 DataBar	jem	0	y	79
GS1 DataBar Limited	jem		{	7B
GS1 DataBar Expanded	jem		}	7D
GS1-128	JC1		l	49
2 of 5				
China Post (Hong Kong 2 of 5)	JX0		Q	51
Interleaved 2 of 5	Jlm	0, 1, 3	e	65
Matrix 2 of 5	JX0		m	6D
NEC 2 of 5	JX0		Y	59
Straight 2 of 5 IATA	JRm	0, 1, 3	f	66
Straight 2 of 5 Industrial	JS0		f	66
MSI	JMm	0, 1	g	67
Telepen	JBm		t	74
UPC		0, 1, 2, 3, 8, 9, A, B, C		
UPC-A	JE0		c	63
UPC-A with Add-On	JE3		c	63
UPC-A with Extended Coupon Code	JE3		c	63
UPC-E	JE0		E	45
UPC-E with Add-On	JE3		E	45
UPC-E1	JX0		E	45

Add Honeywell Code ID				5C80
Add AIM Code ID				5C81
Add Backslash				5C5C
Batch mode quantity			5	35

2D Symbologies

2D Symbology	AIM		Honeywell	
	ID	Possible modifiers (m)	ID	Hex
All Symbologies				99
Aztec Code	jzm	0-9, A-C	z	7A
Chinese Sensible Code (Han Xin Code)	JX0		H	48
Codablock A	JO6	0, 1, 4, 5, 6	V	56
Codablock F	JOm	0, 1, 4, 5, 6	q	71

2D Symbology	AIM		Honeywell	
	ID	Possible modifiers (m)	ID	Hex
Code 49]Tm	0, 1, 2, 4	l	6C
Data Matrix]dm	0-6	w	77
GS1]em	0-3	y	79
GS1 Composite]em	0-3	y	79
GS1 DataBar Omnidirectional]em	0-3	y	79
MaxiCode]Um	0-3	x	78
PDF417]Lm	0-2	r	72
MicroPDF417]Lm	0-5	R	52
QR Code]Qm	0-6	s	73
Micro QR Code]Qm		s	73

Postal Symbologies

Postal Symbology	AIM		Honeywell	
	ID	Possible modifiers (m)	ID	Hex
<i>All Symbologies</i>				99
Australian Post]X0		A	41
British Post]X0		B	42
Canadian Post]X0		C	43
China Post]X0		Q	51
InfoMail]X0		,	2c
Intelligent Mail Bar Code]X0		M	4D
Japanese Post]X0		J	4A
KIX (Netherlands) Post]X0		K	4B
Korea Post]X0		?	3F
Planet Code]X0		L	4C
Postal-4i]X0		N	4E
Postnet]X0		P	50

ASCII Conversion Chart (Code Page 1252)

In keyboard applications, ASCII Control Characters can be represented in 3 different ways, as shown below. The CTRL+X function is OS and application dependent. The following table lists some commonly used Microsoft functionality. This table applies to U.S. style keyboards. Certain characters may differ depending on your Country Code/PC regional settings.

Non-printable ASCII control characters			Keyboard Control + ASCII (CTRL+X) Mode		
DEC	HEX	Char	Control + X Mode Off (KBDCAS0)	Windows Mode Control + X Mode On (KBDCAS2)	
				CTRL + X	CTRL + X function
0	00	NUL	Reserved	CTRL+ @	
1	01	SOH	NP Enter	CTRL+ A	Select all
2	02	STX	Caps Lock	CTRL+ B	Bold
3	03	ETX	ALT Make	CTRL+ C	Copy
4	04	EOT	ALT Break	CTRL+ D	Bookmark
5	05	ENQ	CTRL Make	CTRL+ E	Center
6	06	ACK	CTRL Break	CTRL+ F	Find
7	07	BEL	Enter / Ret	CTRL+ G	
8	08	BS	<i>(Apple Make)</i>	CTRL+ H	History
9	09	HT	Tab	CTRL+ I	Italic
10	0A	LF	<i>(Apple Break)</i>	CTRL+ J	Justify
11	0B	VT	Tab	CTRL+ K	hyperlink
12	0C	FF	Delete	CTRL+ L	list, left align
13	0D	CR	Enter / Ret	CTRL+ M	
14	0E	SO	Insert	CTRL+ N	New
15	0F	SI	ESC	CTRL+ O	Open
16	10	DLE	F11	CTRL+ P	Print
17	11	DC1	Home	CTRL+ Q	Quit
18	12	DC2	PrtScn	CTRL+ R	
19	13	DC3	Backspace	CTRL+ S	Save
20	14	DC4	Back Tab	CTRL+ T	
21	15	NAK	F12	CTRL+ U	
22	16	SYN	F1	CTRL+ V	Paste
23	17	ETB	F2	CTRL+ W	
24	18	CAN	F3	CTRL+ X	
25	19	EM	F4	CTRL+ Y	?
26	1A	SUB	F5	CTRL+ Z	?
27	1B	ESC	F6	CTRL+ [?
28	1C	FS	F7	CTRL+ \	?
29	1D	GS	F8	CTRL+]	?
30	1E	RS	F9	CTRL+ ^	?
31	1F	US	F10	CTRL+ -	?
127	7F	␣	NP Enter		?

Lower ASCII Reference Table

Note: Windows Code page 1252 and lower ASCII use the same characters.

Printable Characters								
DEC	HEX	Character	DEC	HEX	Character	DEC	HEX	Character
32	20	<SPACE>	64	40	@	96	60	`
33	21	!	65	41	A	97	61	a
34	22	"	66	42	B	98	62	b
35	23	#	67	43	C	99	63	c
36	24	\$	68	44	D	100	64	d
37	25	%	69	45	E	101	65	e
38	26	&	70	46	F	102	66	f
39	27	'	71	47	G	103	67	g
40	28	(72	48	H	104	68	h
41	29)	73	49	I	105	69	i
42	2A	*	74	4A	J	106	6A	j
43	2B	+	75	4B	K	107	6B	k
44	2C	,	76	4C	L	108	6C	l
45	2D	-	77	4D	M	109	6D	m
46	2E	.	78	4E	N	110	6E	n
47	2F	/	79	4F	O	111	6F	o
48	30	0	80	50	P	112	70	p
49	31	1	81	51	Q	113	71	q
50	32	2	82	52	R	114	72	r
51	33	3	83	53	S	115	73	s
52	34	4	84	54	T	116	74	t
53	35	5	85	55	U	117	75	u
54	36	6	86	56	V	118	76	v
55	37	7	87	57	W	119	77	w
56	38	8	88	58	X	120	78	x
57	39	9	89	59	Y	121	79	y
58	3A	:	90	5A	Z	122	7A	z
59	3B	;	91	5B	[123	7B	{
60	3C	<	92	5C	\	124	7C	
61	3D	=	93	5D]	125	7D	}
62	3E	>	94	5E	^	126	7E	~
63	3F	?	95	5F	_	127	7F	△

Extended ASCII Characters					
DEC	HEX	CP 1252	ASCII	Alternate Extended	PS2 Scan Code
128	80	€	Ç	up arrow ↑	0x48
129	81		ü	down arrow ↓	0x50
130	82	,	é	right arrow →	0x4B
131	83	f	â	left arrow ←	0x4D
132	84	„	ä	Insert	0x52
133	85	...	à	Delete	0x53
134	86	†	á	Home	0x47
135	87	‡	ç	End	0x4F
136	88	^	ê	Page Up	0x49
137	89	‰	ë	Page Down	0x51
138	8A	Š	è	Right ALT	0x38
139	8B	<	ï	Right CTRL	0x1D

Extended ASCII Characters (Continued)

DEC	HEX	CP 1252	ASCII	Alternate Extended	PS2 Scan Code
140	8C	Œ	î	Reserved	n/a
141	8D		ï	Reserved	n/a
142	8E	Ž	Ā	Numeric Keypad Enter	0x1C
143	8F		Ă	Numeric Keypad /	0x35
144	90		É	F1	0x3B
145	91	‘	æ	F2	0x3C
146	92	’	Æ	F3	0x3D
147	93	“	ô	F4	0x3E
148	94	”	ö	F5	0x3F
149	95	•	ò	F6	0x40
150	96	–	û	F7	0x41
151	97	—	ù	F8	0x42
152	98	˜	ÿ	F9	0x43
153	99	™	Ö	F10	0x44
154	9A	š	Ü	F11	0x57
155	9B	›	ç	F12	0x58
156	9C	œ	£	Numeric Keypad +	0x4E
157	9D		¥	Numeric Keypad -	0x4A
158	9E	ž	Ps	Numeric Keypad *	0x37
159	9F	ÿ	f	Caps Lock	0x3A
160	A0		á	Num Lock	0x45
161	A1	ı	í	Left Alt	0x38
162	A2	ç	ó	Left Ctrl	0x1D
163	A3	£	ú	Left Shift	0x2A
164	A4	¤	ñ	Right Shift	0x36
165	A5	¥	Ñ	Print Screen	n/a
166	A6	ı	ª	Tab	0x0F
167	A7	§	º	Shift Tab	0x8F
168	A8	¨	¿	Enter	0x1C
169	A9	©	ƒ	Esc	0x01
170	AA	ª	¬	Alt Make	0x36
171	AB	«	½	Alt Break	0xB6
172	AC	¬	¼	Control Make	0x1D
173	AD		ı	Control Break	0x9D
174	AE	®	«	Alt Sequence with 1 Character	0x36
175	AF	™	»	Ctrl Sequence with 1 Character	0x1D
176	B0	°	␣		
177	B1	±	␣		
178	B2	²	␣		
179	B3	³	␣		
180	B4	´	␣		
181	B5	µ	␣		
182	B6	¶	␣		
183	B7	·	␣		
184	B8	¸	␣		
185	B9	¹	␣		
186	BA	º	␣		
187	BB	»	␣		
188	BC	¼	␣		
189	BD	½	␣		
190	BE	¾	␣		
191	BF	¿	␣		
192	C0	À	␣		
193	C1	Á	␣		

Extended ASCII Characters (Continued)					
DEC	HEX	CP 1252	ASCII	Alternate Extended	PS2 Scan Code
194	C2	Â	T		
195	C3	Ã	†		
196	C4	Ä	—		
197	C5	Å	í		
198	C6	Æ	‡		
199	C7	Ç	‡		
200	C8	È	‡		
201	C9	É	‡		
202	CA	Ê	‡		
203	CB	Ë	‡		
204	CC	Ì	‡		
205	CD	Í	=		
206	CE	Î	‡		
207	CF	Ï	‡		
208	D0	Ð	‡		
209	D1	Ñ	‡		
210	D2	Ò	‡		
211	D3	Ó	‡		
212	D4	Ô	‡		
213	D5	Õ	F		
214	D6	Ö	‡		
215	D7	×	‡		
216	D8	Ø	‡		
217	D9	Ù	J		
218	DA	Ú	‡		
219	DB	Û	■		
220	DC	Ü	■		
221	DD	Ý	■		
222	DE	Þ	■		
223	DF	ß	■		
224	E0	à	α		
225	E1	á	β		
226	E2	â	Γ		
227	E3	ã	π		
228	E4	ä	Σ		
229	E5	å	σ		
230	E6	æ	μ		
231	E7	ç	τ		
232	E8	è	Φ		
233	E9	é	Θ		
234	EA	ê	Ω		
235	EB	ë	δ		
236	EC	ì	∞		
237	ED	í	φ		
238	EE	î	ε		
239	EF	ï	∩		
240	F0	ð	≡		
241	F1	ñ	±		
242	F2	ò	≥		
243	F3	ó	≤		
244	F4	ô			
245	F5	õ]		
246	F6	ö	÷		
247	F7	÷	≈		

Extended ASCII Characters (Continued)					
DEC	HEX	CP 1252	ASCII	Alternate Extended	PS2 Scan Code
248	F8	ø	°		
249	F9	ù	·		
250	FA	ú	·		
251	FB	û	√		
252	FC	ü	ñ		
253	FD	ý	²		
254	FE	þ	■		
255	FF	ÿ			

ISO 2022/ISO 646 Character Replacements

Code pages define the mapping of character codes to characters. If the data received does not display with the proper characters, it may be because the bar code being scanned was created using a code page that is different from the one the host program is expecting. If this is the case, select the code page with which the bar codes were created. The data characters should then appear properly.

Code Page Selection Method/ Country	Standard	Keyboard Country	Honeywell Code Page Option
United States (standard ASCII)	ISO/IEC 646-IRV	n/a	1
Automatic National Character Replacement	ISO/IEC 2022	n/a	2 (default)
Binary Code page	n/a	n/a	3
Default "Automatic National Character replacement" will select the below Honeywell Code Page options for Code128, Code 39 and Code 93.			
United States	ISO/IEC 646-06	0	1
Canada	ISO /IEC 646-121	54	95
Canada	ISO /IEC 646-122	18	96
Japan	ISO/IEC 646-14	28	98
China	ISO/IEC 646-57	92	99
Great Britain (UK)	ISO /IEC 646-04	7	87
France	ISO /IEC 646-69	3	83
Germany	ISO/IEC646-21	4	84
Switzerland	ISO /IEC 646-CH	6	86
Sweden / Finland (extended Annex C)	ISO/IEC 646-11	2	82
Ireland	ISO /IEC 646-207	73	97
Denmark	ISO/IEC 646-08	8	88
Norway	ISO/IEC 646-60	9	94
Italy	ISO/IEC 646-15	5	85
Portugal	ISO/IEC 646-16	13	92

Code Page Selection Method/ Country	Standard	Keyboard Country	Honeywell Code Page Option
Spain	ISO/IEC 646-17	10	90
Spain	ISO/IEC 646-85	51	91

Dec			35	36	64	91	92	93	94	96	123	124	125	126
Hex			23	24	40	5B	5C	5D	5E	60	7B	7C	7D	7E
US	0	1	#	\$	@	[\]	^	`	{		}	~
CA	54	95	#	\$	à	â	ç	ê	î	ô	é	ù	è	û
CA	18	96	#	\$	à	â	ç	ê	É	ô	é	ù	è	û
JP	28	98	#	\$	@	[¥]	^	`	{		}	-
CN	92	99	#	¥	@	[\]	^	`	{		}	-
GB	7	87	£	\$	@	[\]	^	`	{		}	~
FR	3	83	£	\$	à	°	ç	§	^	μ	é	ù	è	¨
DE	4	84	#	\$	§	Ä	Ö	Ü	^	`	ä	ö	ü	ß
CH	6	86	ù	\$	à	é	ç	ê	î	ô	ä	ö	ü	û
SE/FI	2	82	#	¤	É	Ä	Ö	Å	Ü	é	ä	ö	å	ü
DK	8	88	#	\$	@	Æ	Ø	Å	^	`	æ	ø	å	~
NO	9	94	#	\$	@	Æ	Ø	Å	^	`	æ	ø	å	-
IE	73	97	£	\$	Ó	É	Í	Ú	Á	ó	é	í	ú	á
IT	5	85	£	\$	§	°	ç	é	^	ù	à	ò	è	ì
PT	13	92	#	\$	§	Ã	Ç	Õ	^	`	ã	ç	õ	°
ES	10	90	#	\$	§	i	Ñ	¿	^	`	°	ñ	ç	~
ES	51	91	#	\$	·	i	Ñ	Ç	¿	`	´	ñ	ç	¨
COUNTRY	Country Keyboard	Honeywell CodePage	ISO / IEC 646 National Character Replacements											

Keyboard Key References

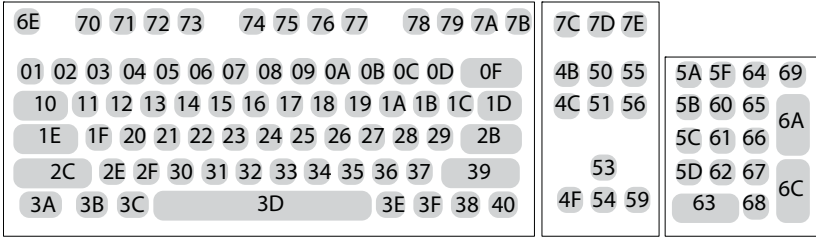

104 Key U.S. Style Keyboard

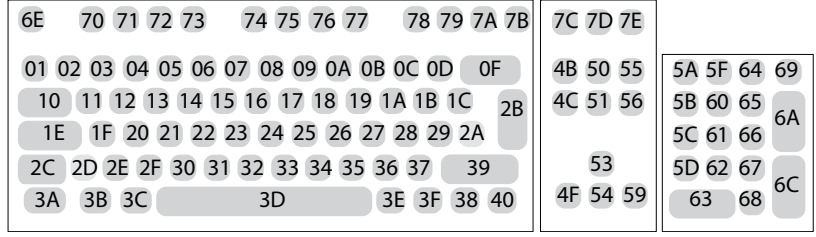

105 Key European Style Keyboard

Sample Symbols

UPC-A

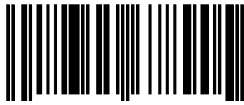

0 123456 7890

Interleaved 2 of 5



01234567890

EAN-13

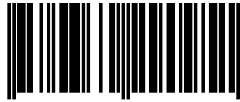

9 780330 290951

Code 128



Code 128

Code 39

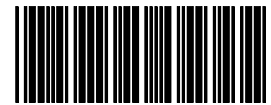

BC321

Codabar

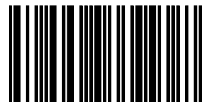

A13579B

Code 93

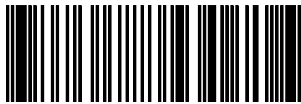

123456-9\$

Straight 2 of 5 Industrial

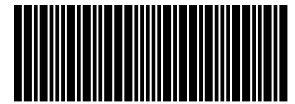

123456

Matrix 2 of 5



6543210

RSS-14



(01) 00123456789012

PDF417



Car Registration

Code 49

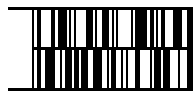

1234567890

Sample Symbols (Continued)

Postnet



Data Matrix



Test Symbol

QR Code



Numbers

MaxiCode

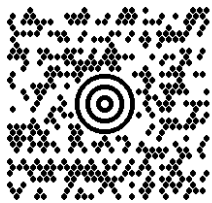

Test Message

Micro PDF417



Test Message

Programming Chart



K0K
0



K2K
2



K4K
4



K6K
6



K8K
8



K1K
1



K3K
3



K5K
5



K7K
7



K9K
9

Programming Chart (Continued)



KAK
A



KBK
B



KCK
C



KDK
D



KEK
E



KFK
F



MNUSAV.
Save



MNUABT.
Discard



RESET_
Reset

*Note: If you make an error while scanning the letters or digits (before scanning **Save**), scan **Discard**, scan the correct letters or digits, and **Save** again.*

Honeywell
9680 Old Bailes Road
Fort Mill, SC 29707

www.honeywellaidc.com