

# MINDEO

## ES4650 Embedded Image Scanner

### User Manual



Version: ES4650\_UM\_EN\_V2.1.3



# Contents

Contents .....	i
Notes about structure and electric circuit design .....	iv
<b>1 Specifications.....</b>	<b>1</b>
1-1 Technical specifications .....	1
1-2 Default setting for each barcode .....	3
<b>2 Getting started .....</b>	<b>4</b>
2-1 Parts of scanner.....	4
2-2 Electrical interface/Pin assignment of cable connector .....	5
2-3 Typical input/output, LDO external, and DC/DC circuitries .....	7
2-4 Installation guide .....	8
2-4-1 Mounting .....	8
2-4-2 Scan window positioning .....	9
2-5 Notes of timing .....	10
2-5-1 Timing characteristics.....	10
2-5-2 Timing waveforms .....	10
2-6 Operation of Embedded Scanner .....	11
2-6-1 Request revision.....	11
2-6-2 Decode by pulling down pin TRIG .....	11
2-6-3 Decode by commands.....	12
<b>3 Parameter menus .....</b>	<b>13</b>
3-1 Introduction .....	13
3-2 Example 1: Single-parameter setting by scanning 1D barcodes.....	14
3-3 Example 2: Multiple-parameter setting by scanning a QR code barcode.....	15
3-4 RS-232 interface .....	16
3-5 USB interface.....	19
3-6 Scan mode & some global settings.....	22
3-7 Indication .....	28
3-8 Decode illumination mode and Decode aiming pattern.....	29
3-9 Single type of barcode, Multi-symbols, and Vertical centering read.....	31
Note 1 : The instruction of calibrating the aimer in vertical centering direction .....	33
Note 2 : Scan barcode or send command to enter upgrade mode .....	34
3-10 DPM, Structured append symbols, and Mobile screen read .....	35
3-11 UPC-A.....	37
3-12 UPC-E.....	39
3-13 UPC-E1.....	41
3-14 EAN-13 .....	43
3-15 EAN-8 .....	45
3-16 Code 39 (Code 32, Trioptic Code 39) .....	47
3-17 Interleaved 2 of 5 .....	50

3-18 Industrial 2 of 5 .....	52
3-19 Matrix 2 of 5 .....	53
3-20 Codabar .....	55
3-21 Code 128 .....	57
3-22 UCC/EAN 128 (GS1-128) .....	59
3-23 ISBT 128.....	61
3-24 Code 93 .....	63
3-25 Code 11 .....	65
3-26 MSI/Plessey.....	67
3-27 UK/Plessey .....	69
3-28 China Post .....	71
3-29 GS1 DataBar (GS1 DataBar Truncated).....	72
3-30 GS1 DataBar Limited .....	73
3-31 GS1 DataBar Expanded .....	74
3-32 GS1 Composite.....	75
3-33 PDF417.....	77
3-34 MicroPDF417 .....	78
3-35 QR Code.....	79
3-36 Data Matrix .....	80
3-37 Han Xin Code .....	81
3-38 Aztec Code .....	82
3-39 MicroQR Code .....	83
3-40 GM code .....	84
3-41 G1-G6 & C1-C2 & FN1 substitution string setting .....	85
3-42 G1-G4 string position & Code ID position .....	89
3-43 String transmission .....	90
<b>4 Serial Communication Interface (SCI) .....</b>	<b>93</b>
4-1 Programming command syntax .....	94
4-1-1 Single-parameter setting .....	94
4-1-2 Multiple-parameter setting.....	95
4-1-3 Query command syntax .....	95
4-1-4 Start Decode & Stop Decode .....	96
4-1-5 Return default parameters & firmware revision .....	96
4-1-6 Get Image.....	97
4-1-7 Responses .....	97
4-2 Examples of setting and query commands .....	98
<b>5 Enable &amp; Disable "NR" .....</b>	<b>100</b>
<b>6 Enable &amp; Disable configuration by scanning barcode .....</b>	<b>101</b>
<b>7 Barcode representing non-printable character.....</b>	<b>102</b>
<b>8 ASCII table.....</b>	<b>103</b>
<b>9 Test symbols.....</b>	<b>104</b>

10 Return default parameters & firmware version.....	109
11 Configuration alphanumeric entry barcode .....	110

## Notes about structure and electric circuit design

1. The embedded scanner must be electrically isolated.
2. Leave sufficient space to accommodate the maximum size of the embedded scanner.

# 1 Specifications

## 1-1 Technical specifications

<b>Dimensions</b>	43.5 mm × 41.0 mm × 19.0 mm (Height × Width × Depth)		
<b>Weight</b>	89 g (without cable)		
<b>Case Material</b>	Zinc alloy		
<b>Scan Window Material</b>	Tempered optical glass		
<b>Indicator Interface</b>	Beeper		
<b>Interface Supported</b>	RS-232 (3.3 V TTL-level), USB, USB virtual COM		
<b>Trigger Mode</b>	Hand-held, Auto-detect, Command		
<b>Programming Method</b>	Scanning special barcodes in sequence, or sending commands via RS-232 or USB virtual COM interface		
<b>Firmware Upgrade</b>	Online		
<b>Input Voltage</b>	5±0.25 VDC		
<b>Current</b>	Standby: 35 mA (RS232); 120 mA (USB); Scanning: 500 mA @ 5 VDC		
<b>Illumination LED</b>	White emitting color, 5000K		
<b>Aiming LED</b>	525 nm peak wavelength, green LED		
<b>Image Size</b>	1280 × 800 pixels		
<b>Scanner Field of View</b>	Horizontal: 41°, Vertical: 28°		
<b>Scanning Angles</b>	± 70°, ± 72°, 360° (Skew, Pitch, Roll)		
<b>Print Contrast</b>	20% minimum reflective difference		
<b>Decoding Capability</b>	1D: UPC-A, UPC-E, UPC-E1, EAN-13, EAN-8, ISBN (Bookland EAN), ISSN, Code 39, Code 39 full ASCII, Code 32, Trioptic Code 39, Interleaved 2 of 5, Industrial 2 of 5, Matrix 2 of 5, Codabar (NW7), Code 128, ISBT 128, Code 93, Code 11 (USD-8), MSI/Plessey, UK/Plessey, UCC/EAN 128 (GS1-128), China Post, GS1 DataBar (formerly RSS) variants		
	2D: PDF417, MicroPDF417, QR Code, DataMatrix, Han Xin Code, Aztec Code, GS1 Composite, MicroQR Code, GM code		
<b>Minimum Resolution</b>	HD: 1D (Code 39): 3mil SR: 1D (Code 128): 5mil		
<b>Decoding Depth</b>		High density (HD)	Standard range (SR)
	3 mil Code 39 (3 chars)	3.5cm - 9.5cm	/
	5 mil Code 128 (3 chars)	2.5cm - 13.5cm	5.5cm - 14.0cm
	13 mil UPC (6 chars)	2.0cm - 28.0cm	1.5cm - 33.0cm
	20 mil Code 39 (1 char)	2.5cm - 40.0cm	2.5cm - 56.0cm
	5 mil QR (40 chars)	4.0cm - 7.5cm	/
	6.7 mil PDF417 (20 chars)	2.5cm - 13.5cm	4.5cm - 14.0cm
	10 mil QR (20 chars)	1.0cm - 15.0cm	2.0cm - 15.0cm
20 mil QR (20 chars)	1.5cm - 28.0cm	2.0cm - 34.0cm	
<b>Temperature</b>	-20°C to 50°C (-4°F to 122°F), operating; -20°C to 70°C (-4°F to 158°F), storage		
<b>Humidity</b>	5% to 95% (non-condensing)		

<p><b>Mechanical Vibration</b></p>	<p>IEC60064-2-6  Un-powered scanner withstands a random vibration along each of the X, Y and Z axes for a period of one hour per axis, define as follows:  20 Hz to 80 Hz          Ramp up to 0.04 G<sup>2</sup>/Hz at the rate of 3 dB/oct  80 Hz to 350 Hz        0.04 G<sup>2</sup>/Hz  350 Hz to 2000 Hz      Ramp down at the rate of 3 dB/oct</p>
<p><b>Mechanical Shock</b></p>	<p>IEC60064-2-27  Shock pulse: 0.5 ms, Maximal acceleration: 1500 G, Shock direction &amp; time: ± X-axis, ± Y-axis, ± Z-axis, 3 times for each direction, total of 18 times.</p>
<p><b>Safety</b></p>	<p>Photobiological Safety: EN62471:2008  EMC: EN55032 ; EN55024  ESD Protection: contact discharge: ± 4 KV, air discharge: ± 8 KV  Sealing: IP51  Drop Resistance: Withstands multiple 1.5 m (5 ft.) drops to concrete  RF Immunity: IEC61000-4-3, 10 V/m  Artificial Light Immunity: 100,000 Lux</p>



## 1-2 Default setting for each barcode

Code type	Read enable	Check digit verification	Check digit transmissio	Min. code length	Proprietary code ID	AIM code ID
UPC-A	√	√	√	(12) <sup>2</sup>	A	]Em
UPC-E	√	√	√	(8) <sup>2</sup>	D	]Em
UPC-E1	-	√	√	(8) <sup>2</sup>	D	]Em
EAN-13	√	√	√	(13) <sup>2</sup>	A	]Em
EAN-8	√	√	√	(8) <sup>2</sup>	C	]Em
ISBN (Bookland EAN)	√	√	√	(13) <sup>2</sup>	B	]Em
Code 39	√	-	-	1	M	]Am
Interleaved 2 of 5	√	-	-	6	I	]Im
Industrial 2 of 5	-	-	-	4	H	]Im
Matrix 2 of 5	√	-	-	6	X	]Im
Codabar	√	-	-	4	N	]Fm
Code 128	√	√	-	1	K	]Cm
UCC/EAN 128	√	√	-	1	K	]Cm
ISBT 128	√	√	-	1	K	]Cm
Code 93	√	√	-	1	L	]Gm
Code 11	-	√	-	4	V	-
MSI/Plessey	-	-	-	4	O	]Mm
UK/Plessey	-	√	-	1	U	]Mm
China Post	√	-	-	(11) <sup>2</sup>	T	]Im
GS1 DataBar	√	-	-	(16) <sup>2</sup>	R	]em
GS1 DataBar Truncated <sup>3</sup>	√	-	-	(16) <sup>2</sup>	R	]em
GS1 DataBar Limited	√	-	-	(16) <sup>2</sup>	R	]em
GS1 DataBar Expanded	√	-	-	1	R	]em
PDF417	√	-	-	-	p	]Lm
MicroPDF417					p	]Lm
DataMatrix	√	-	-	-	d	]dm
QR code	√	-	-	-	q	]Qm
MicroQR Code	-	-	-	-	q	]Qm
Han Xin Code	-	-	-	-	h	]Xm
Aztec Code	-	-	-	-	a	]zm

Note: <sup>1</sup>The settings for ISBN/ISSN and EAN-13 must be the same except the code ID.

<sup>2</sup> Fixed-length barcodes.

<sup>3</sup>The settings for GS1 DataBar Truncated and GS1 DataBar must be the same.

# 2 Getting started

## 2-1 Parts of scanner

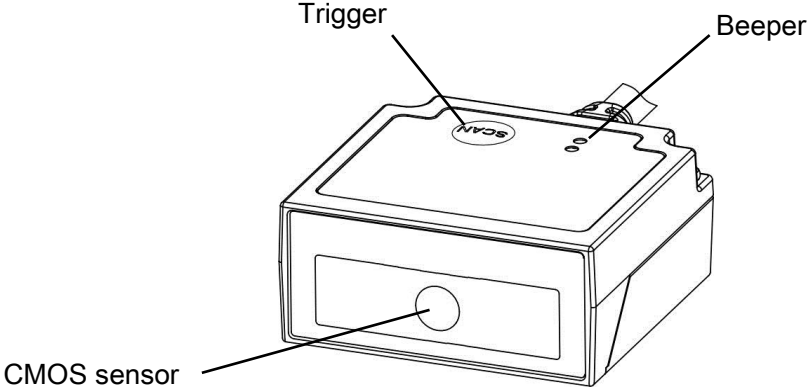


Figure 2-1 Appearance

## 2-2 Electrical interface/Pin assignment of cable connector

The embedded scanner has a RJ-45 cable connector. Table 2-1 lists the pin assignments of the embedded scanner.

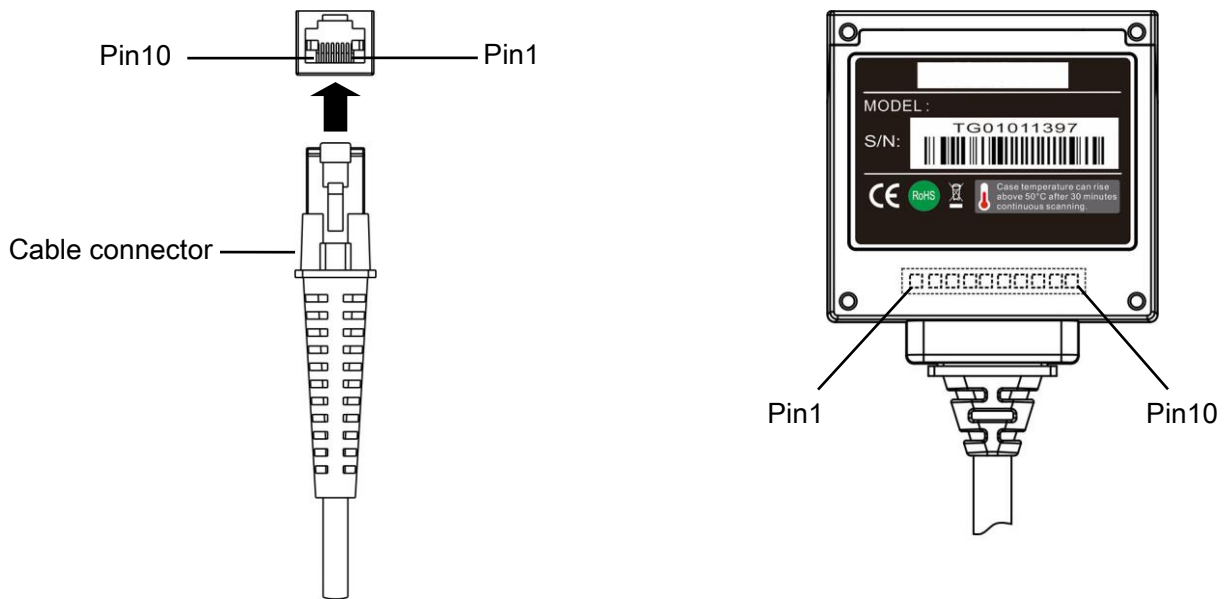


Figure 2-2 Electrical interface/Pin assignment

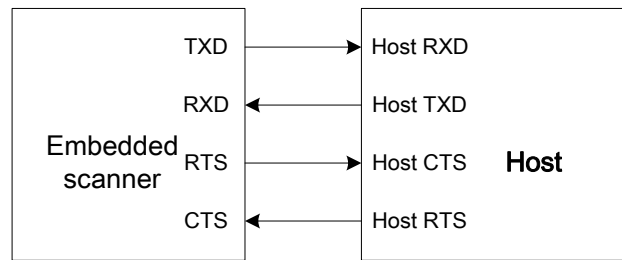
Table 2-1 Electrical interface/Pin assignment

Pin No.	RS-232		USB		Descriptions
	Pin/Signal Name	Type	Pin/Signal Name	Type	
1	Power (5V)	Power	Power (5V)	Power	Power: +5 VDC
2	NC	-	NC	-	NC: No connection
3	Ground	Power	Ground	Power	Ground: 0V reference
4	3.3V (for interface auto selection)	Input	Ground (for interface auto selection)	Input	RS-232: Logic high level, 3.3V USB: Logic low level, 0V reference
5	TXD	Output	NC	-	RS-232: Serial data transmit output port (Transmitted data)
6	RXD	Input	NC	-	RS-232: Serial data receive input port (Received data)
7	NC	-	NC	-	NC: No connection
8	TRIG	Input	TRIG	Input	Trigger. Logic low level (activity): 0V reference Logic high level: 3.3V
9	CTS	Input	D-	-	RS-232: Handshaking line (Clear-to-send). USB: Negative differential line.
10	RTS	Output	D+	-	RS-232: Handshaking line (Request-to-send). USB: Positive differential line.

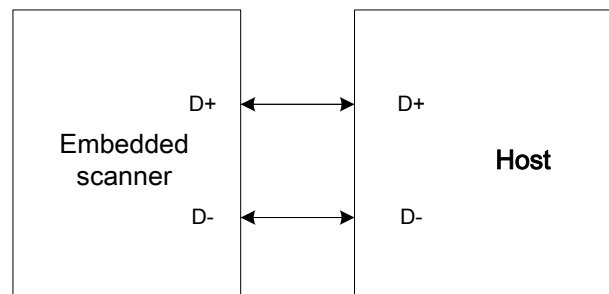
Note: Voltage level of all RS-232 Pin-outs (RXD, TXD, CTS and RTS) is 0V for logic low level and 3.3V for logic high level.

The embedded scanner has a TTL-level RS-232 interface to communicate with a host. RTS and CTS are only used for hardware flow control and should be leaved unconnected or tied to  $V_{CC}$  by 100K Ohm resistors when they are not used.

The following diagram demonstrates the interconnection.

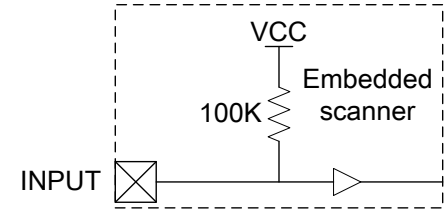
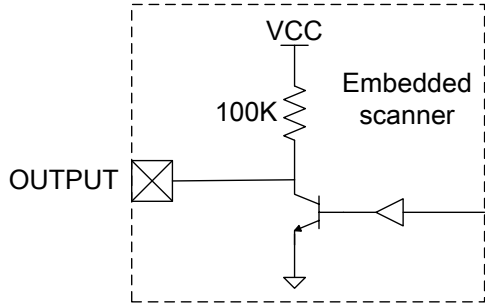
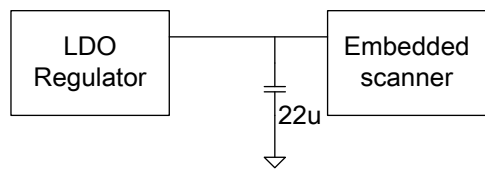
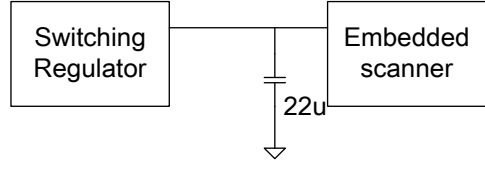


**Figure 2-3 Embedded scanner and Host interconnection via RS-232**



**Figure 2-4 Embedded scanner and host interconnection via USB**

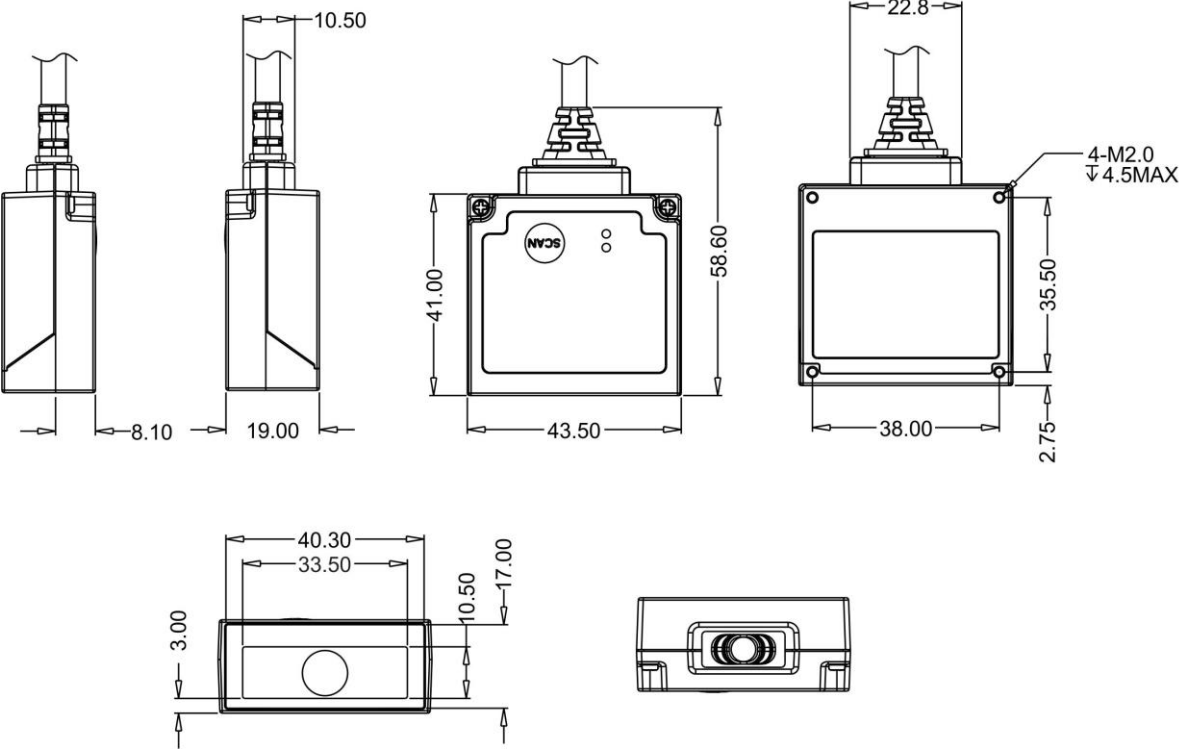
## 2-3 Typical input/output, LDO external, and DC/DC circuitries

<p>Input: each input IO pin is internally pulled up by a 100K Ohm resistor (<math>V_{CC}=3.3V</math>).</p> <table border="1" data-bbox="231 380 686 537"> <thead> <tr> <th></th> <th>Min.</th> <th>Max.</th> </tr> </thead> <tbody> <tr> <td><math>V_{inL}</math></td> <td>-0.3V</td> <td>0.7V</td> </tr> <tr> <td><math>V_{inH}</math></td> <td>2.4V</td> <td>3.6V</td> </tr> </tbody> </table>		Min.	Max.	$V_{inL}$	-0.3V	0.7V	$V_{inH}$	2.4V	3.6V	 <p>The diagram shows an input pin labeled 'INPUT' connected to a 100K resistor that is pulled up to a VCC supply. The other end of the resistor is connected to an 'Embedded scanner' block.</p>
	Min.	Max.								
$V_{inL}$	-0.3V	0.7V								
$V_{inH}$	2.4V	3.6V								
<p>Output: each output port is an open-drain pad with a 100K Ohm pull-up resistor and the maximum sink current is 100 mA (<math>V_{CC}=3.3V</math>).</p>	 <p>The diagram shows an output pin labeled 'OUTPUT' connected to the collector of an NPN transistor. A 100K resistor is connected between the collector and a VCC supply. The emitter of the transistor is connected to ground. The base of the transistor is connected to an 'Embedded scanner' block.</p>									
<p>External LDO circuitry: it is recommended to apply low noise LDO (Low Dropout Voltage) regulators.</p>	 <p>The diagram shows a block labeled 'LDO Regulator' connected to a block labeled 'Embedded scanner'. A 22uF capacitor is connected between the output of the LDO Regulator and ground.</p>									
<p>External switching regulator circuitry:</p> <table border="1" data-bbox="199 1601 726 1769"> <thead> <tr> <th></th> <th>Min.</th> <th>Max.</th> </tr> </thead> <tbody> <tr> <td>Switching Frequency</td> <td>1 MHz</td> <td>-</td> </tr> <tr> <td>Ripple <math>V_{P-P}</math></td> <td>-</td> <td>50 mV</td> </tr> </tbody> </table>		Min.	Max.	Switching Frequency	1 MHz	-	Ripple $V_{P-P}$	-	50 mV	 <p>The diagram shows a block labeled 'Switching Regulator' connected to a block labeled 'Embedded scanner'. A 22uF capacitor is connected between the output of the Switching Regulator and ground.</p>
	Min.	Max.								
Switching Frequency	1 MHz	-								
Ripple $V_{P-P}$	-	50 mV								

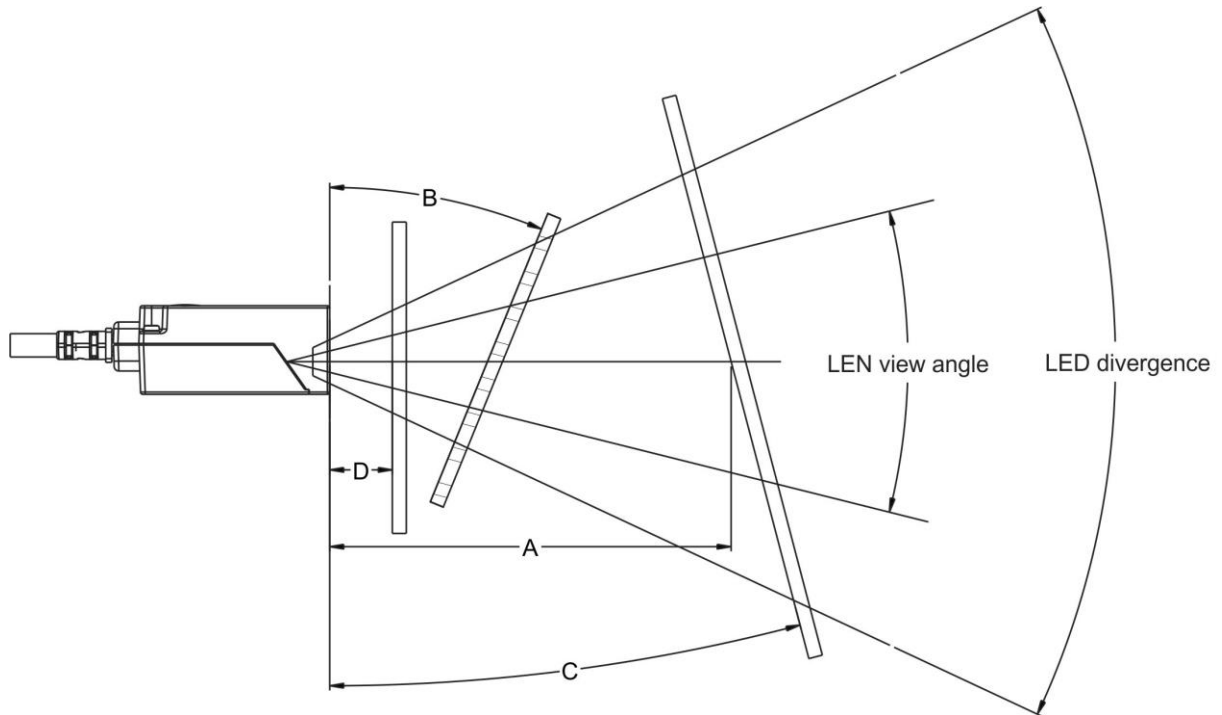
# 2-4 Installation guide

## 2-4-1 Mounting

(Units = mm)



## 2-4-2 Scan window positioning



<b>A</b>	Scan Window Distance from Scanner (mm)	0	1	2	3	4	5	6	
<b>B</b>	Max. Positive Angle	0°	0°	32°	32°	32°	32°	31°	
<b>C</b>	Min. Negative Angle	0°	0°	32°	32°	32°	32°	31°	
<b>D</b>	Placing the scan window vertically is feasible?	YES		NO					

<b>A</b>	Scan Window Distance from Scanner (mm)	7	8	9	10	11	12	13
<b>B</b>	Max. Positive Angle	31°	31°	31°	31°	30°	30°	30°
<b>C</b>	Min. Negative Angle	31°	31°	31°	31°	30°	30°	30°
<b>D</b>	Placing the scan window vertically is feasible?	NO						

<b>A</b>	Scan Window Distance from Scanner (mm)	14	15	16	17	18	19	20
<b>B</b>	Max. Positive Angle	31°	31°	31°	31°	31°	32°	32°
<b>C</b>	Min. Negative Angle	31°	31°	31°	31°	31°	32°	32°
<b>D</b>	Placing the scan window vertically is feasible?	NO						

Note:

- 1) The scan window is transparent. (Recommended).
- 2) The scan window should be high transparent & non-colored glass.
- 3) If the thickness of the scan window is less than 3 mm, then different thickness of the scan window will not effect the performance of the scanner.

## 2-5 Notes of timing

### 2-5-1 Timing characteristics

Table 2-2 Timing characteristics

Symbol	Parameter	Conditions	Min.	Typ.	Max.	Unit
<b>General characteristics</b>						
$t_r$	Low to high rise time	$C_L=50\text{pf}$			1.0	us
$t_f$	High to low fall time	$C_L=50\text{pf}$			1.0	us
<b>Trigger timing</b>						
$t_{\text{trig}_l}$	Trigger low level hold time		20			ms
$t_{\text{trig}_h}$	Trigger high level hold time		20			ms
$t_{\text{dbt}}$	Trigger de-bounce time				1.1	ms
<b>Wake up timing</b>						
$t_{\text{idle2fo}}$	Idle to Operation				1	ms
$t_{\text{stb2fo}}$	Standby to Operation				7	ms

### 2-5-2 Timing waveforms

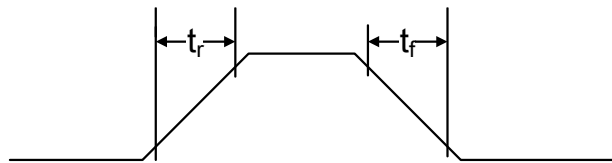


Figure 2-5 General characteristics

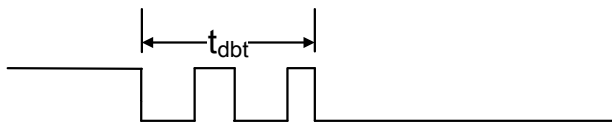


Figure 2-6 Trigger de-bounce timing

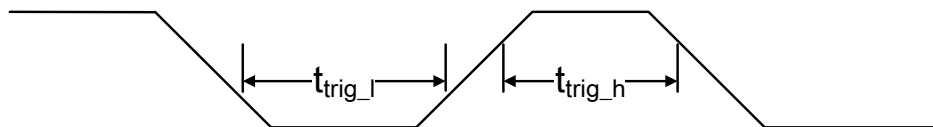


Figure 2-7 Hardware trigger timing

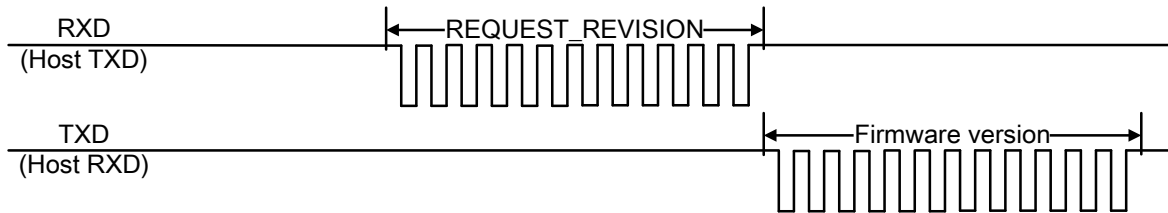


## 2-6 Operation of Embedded Scanner

The following cases demonstrate how a host operates an embedded scanner quickly and easily.

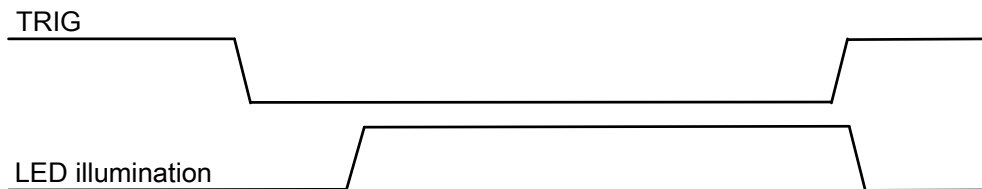
### 2-6-1 Request revision

- 1) Host sends a Firmware Version list command (0x16, 0x4D, 0x0D, 0x25, 0x25, 0x25, 0x56, 0x45, 0x52, 0x2E).
- 2) After receiving the command, Embedded Scanner responds with firmware version.



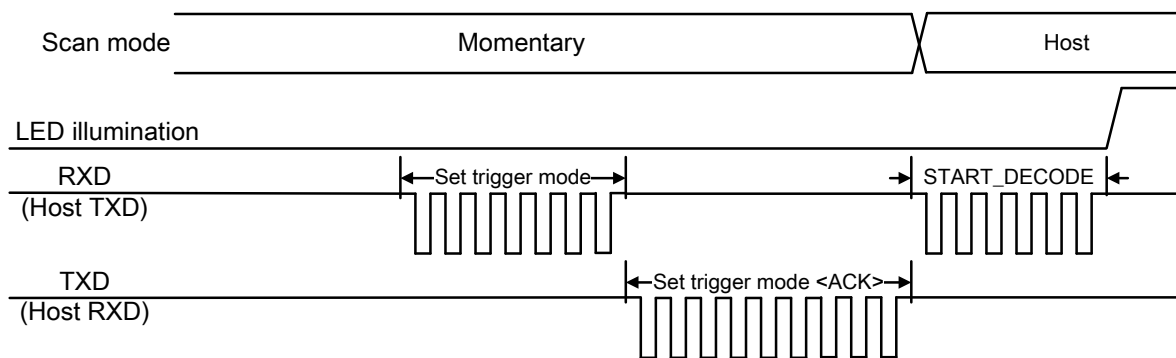
### 2-6-2 Decode by pulling down pin TRIG

- 1) Host pulls down pin TRIG.
- 2) Then Embedded Scanner turns on LED illumination and starts decode. The LED illumination will be turned off if either Scan standby duration expires or Embedded Scanner succeeds in decoding.



### 2-6-3 Decode by commands

- 1) Host sends a command (0x16, 0x4D, 0x0D, 0x30, 0x34, 0x30, 0x31, 0x44, 0x30, 0x35, 0x2E) to set **Scan mode** to Host.
- 2) Then Embedded Scanner responds with the received command and a <ACK> (0x06) character, and then change **Scan mode** to Host.
- 3) After receiving the <ACK> character, Host sends a START\_DECODE command (0x16, 0x54, 0x0D).
- 4) Embedded Scanner turns on LED illumination to decode. The LED illumination will be turned off if either Scan standby duration expires or Embedded Scanner succeeds in decoding. A STOP\_DECODE command (0x16, 0x55, 0x0D) can end decode process.



## 3 Parameter menus

### 3-1 Introduction

This section describes the programmable parameters, to change the parameter values.

- ✚ Refer to [3-2 Example 1: Single-parameter setting by scanning 1D barcodes](#) and [3-3 Example 2: Multiple-parameter setting by scanning a QR code barcode](#), scan the appropriate barcodes included in this section, The new values replace the existing values.
- ✚ To set the new values as custom default settings, scan the Write to Custom Defaults barcode. The factory default settings or custom default settings can be recalled by scanning appropriate barcodes, refer to [10 Return default parameters & firmware version](#).
- ✚ Send parameters through the TTL-level RS-232 or USB virtual COM interface. Instructions of programming and querying the embedded scanner are described in [4-1 Programming command syntax](#).

## 3-2 Example 1: Single-parameter setting by scanning 1D barcodes

### Important notes:

1. After each successful programming, the embedded scanner will beep twice.
2. Throughout the programming barcode menus, the factory default settings are indicated with asterisks (\*).

Two programming modes have been provided as bellows:

#### ❶ Single-scan setting

- Scan the appropriate **Single-scan setting** (e.g. **%0101D00%**) according to the user's demand.

**Example:** To set **Flow control** to be XON/XOFF.

**Steps:** Scan the following barcode.

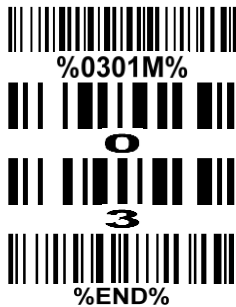


#### ❷ Multiple-scan setting

- Step 1. Scan the **Option barcode** (e.g. **%0101M%**) according to the user's demand.
- Step 2. To the right of the option barcode, the necessary alphanumeric inputs are listed. Scan two alphanumeric entries from **0** to **9** or **A** to **F**, refer to [11 Configuration alphanumeric entry barcode](#).
- Step 3. Repeat Step 2, if more user parameters input are required.
- Step 4. Scan the **%END%** barcode, listed on the lower left hand corner of each parameter setting part.

**Example:** To set **Flow control** to be XON/XOFF.

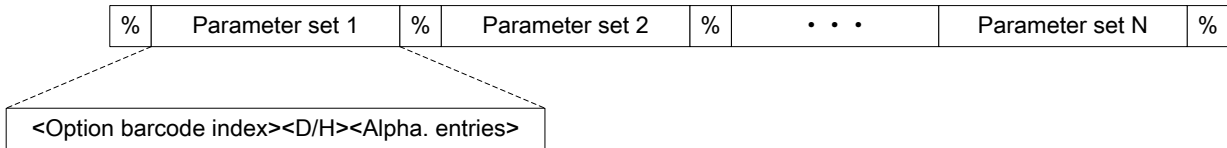
**Steps:** Scan the following barcodes in order.



### 3-3 Example 2: Multiple-parameter setting by scanning a QR code barcode

User can customize a QR code barcode to set multiple parameters. The embedded scanner can set multiple parameters by scanning this single QR code barcode.

1. The data format of the QR code barcode is as following.



Note that:

- <Option barcode index> means the corresponding 4 digits of Option barcode.
- <D/H> means “D” or “H” character. “D” means that the type of alphanumeric entry is decimal; and “H” means that the type of alphanumeric entry is hexadecimal.
- <Alpha. entries> is a character string with various length of 2, 4, or other values.

**Example:** Set 0401->03 (decimal); 8002->0D0A (hexadecimal); 8202->01 (decimal). The customized QR code barcode contents and symbol are as following.

%0401D03%8002H0D0A%8202D01%



2. Notes of making QR code barcode

The model is chosen as M2. Other requirements, e.g. ECC level, Start mode, etc, are not specified.

3. Other notes

- The contents of a QR code barcode can include several same <Option barcode index> associated with same or different <Alpha. entries>. In the case of with different <Alpha. entries>, the latest <Alpha. entries> is the valid one.
- If any one of the parameter settings is invalid, the total setting is failed. The invalid setting can be caused by one of the following problems: invalid <Option barcode index>, invalid type of <D/H>, invalid type, length or value range of <Alpha. entries>, etc.

## 3-4 RS-232 interface

### Flow control:

**None** - The communication only uses TXD and RXD signals without any hardware or software handshaking protocol.

**RTS/CTS** – If the embedded scanner wants to send the barcode data to the host, it will assert the RTS signal first, and then waits for the CTS signal from the host to perform normal data communication. If CTS is not asserted in Response delay, the embedded scanner will issue an error indication.






















**Two-direction flow control** - The embedded scanner asserts the RTS signal when it is OK for the host to transmit. The host asserts CTS when it is OK for the device to transmit.

















**XON/XOFF** – An <XOFF> character turns the embedded scanner's transmission off until the embedded scanner receives an <XON> character.

**ACK/NAK** – After transmitting data, the embedded scanner expects either an <ACK> character (acknowledge) or <NAK> character response from the host. When a <NAK> character is received, the embedded scanner transmits the same data again and waits for either an <ACK> character or <NAK> character. After three unsuccessful attempts to send data when <NAK> characters are received the embedded scanner issues an error indication and discards the data.

**Inter-character delay:** This delay is inserted after each data character transmitted.

**Response delay:** This delay is used for serial communication of the embedded scanner when it waits for a handshaking acknowledgment from the host.

Multiple-scan setting			Single-scan setting
Option barcode	Option	Alpha. entry	
Flow control  %0301M%	None	00*	 %0301D00% *
	RTS/CTS	01	 %0301D01%
	Two-direction flow control	02	 %0301D02%
	XON/XOFF	03	 %0301D03%
	ACK/NAK	04	 %0301D04%
Inter-character delay  %0302M%	0 ms	00*	 %0302D00% *
	5 ms	01	 %0302D01%
	10 ms	02	 %0302D02%
	20 ms	03	 %0302D03%
	40 ms	04	 %0302D04%
	80 ms	05	 %0302D05%
Response delay  %0304M%	00-99 (100 ms)	00-99	
		00*	 %0304D00% *
Baudrate  %0305M%	300	00	 %0305D00%
	600	01	 %0305D01%
	1200	02	 %0305D02%
	2400	03	 %0305D03%
	4800	04	 %0305D04%

Multiple-scan setting			Single-scan setting
Option barcode	Option	Alpha. entry	
	9600	05*	 %0305D05% *
	19200	06	 %0305D06%
	38400	07	 %0305D07%
	57600	08	 %0305D08%
	115200	09	 %0305D09%
Parity bit  %0306M%	None	00*	 %0306D00% *
	Odd	01	 %0306D01%
	Even	02	 %0306D02%
Data bit  %0307M%	8 bits	00*	 %0307D00% *
	7 bits	01	 %0307D01%
Stop bit  %0308M%	1 bit	00*	 %0308D00% *
	2 bits	01	 %0308D01%
 %END%			



## 3-5 USB interface

### USB device type:

**HID keyboard** – By setting, the embedded scanner is used as a USB HID keyboard emulation device.

**USB virtual COM** – By setting, the embedded scanner emulates a regular RS-232-based COM port. If a Microsoft Windows PC is connected to the embedded scanner, a driver is required to install on the connected PC. The driver will use the next available COM Port number. The driver and the installation guide can be found in the associated CD and on the manufacturer's website. A Windows-based software COM\_Text is recommended to display the barcode data in text format. COM\_Text emulates some kind of serial-key typing.

**Simple COM Port Emulation** - Please contact the manufacturer for the instruction.

### Notes:

- 1) When change **USB Device Type**, the embedded scanner automatically restarts.
- 2) **USB Device Type** will be changed to USB virtual COM if **Scan Mode** is set as Host. Besides, the change of **USB Device Type** from the USB virtual COM to others is forbidden when **Scan Mode** is Host.

**Keyboard layout:** The embedded scanner supports different national keyboard layouts.

**Inter-character delay:** This delay is inserted after each data character transmitted. By selecting, the user can change the output speed of the embedded scanner to match the speed of the host USB communication port.

### **Numeric key:**


















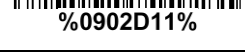
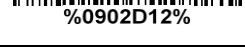
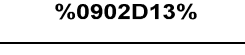
**Alphabetic key** - The embedded scanner will output code result as alphabetic key.






















**Numeric key** - The embedded scanner will output code result as pressing numeric keypad ( '0', '1', '2', '3', '4', '5', '6', '7', '8', '9', '.', '+', '-', '/', '\*' only).

**Alt+ keypad** - The embedded scanner will output code result as pressing Alt+ numeric key (on keypad).

Note that the Num Lock control key must be ON. This setting can be specially adapted for use with different national keyboard layout.

**USB function code:** It can support the output and prohibition of non-printable-characters, as well as the output and prohibition of function codes corresponding to non-printable-characters.

Multiple-scan setting			Single-scan setting
Option bar code	Option	Alpha. entry	
USB device type  %0901M%	HID keyboard	00*	 %0901D00% *
	HID keyboard for Apple Mac	01	 %0901D01%
	USB virtual COM	02	 %0901D02%
	Simple COM Port Emulation	03	 %0901D03%
Keyboard layout  %0902M%	USA	00*	 %0902D00% *
	Turkish F	01	 %0902D01%
	Turkish Q	02	 %0902D02%
	French	03	 %0902D03%
	Italian	04	 %0902D04%
	Spanish	05	 %0902D05%
	Slovak	06	 %0902D06%
	Denmark	07	 %0902D07%
	Japanese	08	 %0902D08%
	German	09	 %0902D09%
	Belgian	10	 %0902D10%
	Russian	11	 %0902D11%
	Czech	12	 %0902D12%
Thai	13	 %0902D13%	

Multiple-scan setting			Single-scan setting
Option bar code	Option	Alpha. entry	
	Hungary	14	 %0902D14%
	Swiss German	15	 %0902D15%
	Portugal	16	 %0902D16%
Inter-character delay  %0903M%	0 ms	00	 %0903D00%
	5 ms	01*	 %0903D01% *
	10 ms	02	 %0903D02%
	20 ms	03	 %0903D03%
	40 ms	04	 %0903D04%
	60 ms	05	 %0903D05%
Numeric key  %0904M%	Alphabetic key	00*	 %0904D00% *
	Numeric keypad	01	 %0904D01%
	Alt + keypad	02	 %0904D02%
	GBK	03	 %0904D03%
	BIG5	04	 %0904D04%
	THAI	05	 %0904D05%
USB function code  %0905M%	Output non-printing characters	00	 %0905D00%
	Output function codes corresponding to non-printable-characters.	01	 %0905D01%
	Prohibition output of non-printable-character	03	 %0905D03%



## 3-6 Scan mode & some global settings

### Scan mode:

**Good-read off** – The trigger pin must be pulled down once to activate scanning. The scanner stops scanning when there is a successful reading or no code is decoded after the `Scan standby duration` elapsed.

**Momentary** – Pin TRIG acts as a switch. Pull down pin TRIG to activate scanning and pull up the trigger to stop scanning. The scanner stops scanning when there is a successful reading or no code is decoded after the `Scan standby duration` elapsed.

**Alternate** – Pin TRIG acts as a toggle switch. Pull pin TRIG to activate or stop scanning.

**Continuous** – The embedded scanner always keeps scanning, and it does not matter when pin TRIG is pulled down or `Scan standby duration` is elapsed.

**Host** – A START\_DECODE command issues the triggering signal. In this mode, the embedded scanner interprets an actual trigger pull as a Good-read off scanning option. There is a practical application in [2-6-4 Decode by commands](#).

**Good-read on** – The trigger pin must be pulled down once to activate scanning. The scanner stops scanning when no code is decoded after the `Scan standby duration` elapsed.

**Auto-detection- Good-read on** – By setting Enable, the scanner will start scanning if any nearby object has been detected. The scanner stops scanning when no code is successful decoded after the `Stand-by duration` elapsed. Once the scanner stops scanning, the present object must be removed to enable `Auto-detection`.

**Auto-detection- Good-read off** – By setting Enable, the scanner will start scanning if any nearby object has been detected. The scanner will stop scanning when there is a successful reading or no code is decoded after the `Stand-by duration` elapsed. Once the scanner stops scanning, the present object must be removed to enable `Auto-detection`.

**Barcode detection:** In image auto-induction mode, barcode detection means that the scanner detects an object similar to a barcode to trigger decoding, such as text, graphics, barcodes, and so on.

**Barcode detection delay:** The barcode detection delay means that the detection function is enabled when no object is detected within the set delay. **Same barcode delay time for 1D symbol:** If a 1D barcode has been scanned and output once successfully, the scanner must output the same barcode data beyond delay time. When this feature is set to be “0xFF”, then the delay time is indefinite.

**Same barcode delay time for 2D symbol:** If a 2D barcode has been scanned and output once successfully, the scanner must output the same barcode data beyond delay time. When this feature is set to be “0xFF”, then the delay time is indefinite.

**Double confirm:** If it is enabled, the scanner will require a several times of same-decoded-data to confirm a valid reading.

**Global Max./Min. code length for 1D symbol:** These two lengths are defined as the valid range of decoded 1D barcode data length. Make sure that the minimum length setting is no greater than the maximum length setting, or otherwise the labels of the symbol will not be readable. In particular, the same value can be set for both minimum and maximum reading length to force the fixed length barcode

decoded.

Notes:

1. Please set the max./min. length for individual barcode in later sections, if special demand is requested.

2. The number of check digits is included in max./min. code length.

3. These two settings have no effect on the symbols with fixed-length, e.g. UPC-A, UPC-E, EAN-13, EAN-8 and China Post.

**Global G1-G6 string selection:** The scanner offer one or two string group for all symbols. By setting one or two digits to indicate which string group you want to apply. You may refer to [3-41 G1-G6 & C1-C2 & FN1 substitution string setting](#) and [3-42 G1-G4 string position & Code ID position](#).

Example: Group 1 → set 01 or 10. Group 2 and 4 → set 24 or 42.

All valid settings include 00, 01, 02, 03, 04, 05, 06, 10, 11, 12, 13, 14, 15, 16, 20, 21, 22, 23, 24, 25, 26, 30, 31, 32, 33, 34, 35, 36, 40, 41, 42, 43, 44, 45, 46, 50, 51, 52, 53, 54, 55, 56, 60, 61, 62, 63, 64, 65 and 66.

**Element amendment:** If it is enabled, the scanner can read the barcode comprised with bars and spaces in different scale.



























**Decoder optimization:** If it is enabled, the scanner will optimize the decoder with error correction. This function is not effective for all types of barcode.























**Character encoding system:** A character encoding system consists of a code that pairs each character from a given repertoire. Common examples include Morse code, the Baudot code, the ASCII and Unicode. If the data received does not display with the proper characters (domestic language, e.g. Chinese), it maybe because the barcode being scanned was created using a character encoding system that is different from the one the host program is expecting. Try alternate options to find the proper one.
















**Complete data output before next decode attempt:** This setting is active only when  is set as "HID keyboard" or "HID keyboard for Apple Mac", refer to [3-5 USB interface](#). If it is enabled, the scanner will not start next decode attempt until previous data output is completed.

**Sleep mode:** If it is enabled, the scanner will go to sleep when no code is successful decoded after the  elapsed.






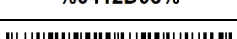
**Sleep mode delay:** When no code is successful decoded beyond this time, the scanner will go to sleep.

Multiple-scan setting			Single-scan setting
Option barcode	Option	Alpha. entry	
Scan mode  %0401M%	Good-read off	00	 %0401D00%
	Momentary	01	 %0401D01%
	Alternate continue	02	 %0401D02%
	Continue	03	 %0401D03%
	Time-out off	04	 %0401D04%
	Host	05	 %0401D05%
	Auto-detection- Good-read on	06	 %0401D06%
	Auto-detection- Good-read off	07	 %0401D07%
Barcode detection  %0604M%	Disable*	00*	 %0604D00% *
	Enable	01	 %0604D01%
Barcode detection delay  %0606M%	Always detection	00	 %0606D00%
	5 seconds	01	 %0606D01%
	10 seconds	02	 %0606D02%
	30 seconds	03	 %0606D03%
	60 seconds	04	 %0606D04%
	Never detection	05*	 %0606D05% *
Standby duration  %0402M%	4 seconds	00*	 %0402D00% *
	8 seconds	01	 %0402D01%
	16 seconds	02	 %0402D02%
	24 seconds	03	 %0402D03%
	30 seconds	04	 %0402D04%
	1 minute	05	 %0402D05%

Multiple-scan setting			Single-scan setting
Option barcode	Option	Alpha. entry	
	1.5 minutes	06	 %0402D06%
	2 minutes	07	 %0402D07%
	5 minutes	08	 %0402D08%
	7 minutes	09	 %0402D09%
	10 minutes	10	 %0402D10%
	15 minutes	11	 %0402D11%
	20 minutes	12	 %0402D12%
	30 minutes	13	 %0402D13%
	45 minutes	14	 %0402D14%
	1 hour	15	 %0402D15%
Same barcode delay time for 1D symbol  %0403M%	00-FF <sub>16</sub> (50 ms)	00-FF <sub>16</sub>	
		00	 %0403H00%
		08*	 %0403H08% *
Same barcode delay time for 2D symbol  %0415M%	00-FF <sub>16</sub> (50 ms)	00-FF <sub>16</sub>	
		00	 %0415H00%
		08*	 %0415H08% *
Double confirm  %0404M%	00-09 (00: no )	00-09	
		00*	 %0404D00% *
Global max. code length for 1D symbol  %0405M%	01-99	01-99	
		99*	 %0405D99% *
Global min. code length for 1D symbol  %0406M%	01-99	01-99	
		04*	 %0406D04% *

Multiple-scan setting			Single-scan setting
Option barcode	Option	Alpha. entry	
Global G1-G6 string selection  %0407M%	00-66	00-66	
		00*	 %0407D00% *
Element amendment  %0408M%	Disable	00	 %0408D00%
	Enable	01*	 %0408D01% *
Decoder optimization  %0410M%	Disable	00	 %0410D00%
	Enable	01*	 %0410D01% *
Character encoding system  %0413M%	ASCII	00*	 %0413D00% *
	UTF-8	01	 %0413D01%
	Windows-1251	02	 %0413D02%
	Simplified Chinese	03	 %0413D03%
	Traditional Chinese	04	 %0413D04%
	Windows-1250	05	 %0413D05%
	KOI8R	06	 %0413D06%
	Japanese	07	 %0413D07%
Complete data output before next decode attempt  %0414M%	Disable	00*	 %0414D00%
	Enable	01	 %0414D01%
Sleep mode  %0416M%	Disable	00	 %0416D00%
	Enable	01*	 %0416D01% *
Sleep mode delay  %0412M%	1 second	00	 %0412D00%
	5 seconds	01	 %0412D01%
	10 seconds	02	 %0412D02%
	30 seconds	03	 %0412D03%



Multiple-scan setting			Single-scan setting
Option barcode	Option	Alpha. entry	
	60 seconds (1 minute)	04	 %0412D04%
	300 seconds (5 minutes)	05*	 %0412D05% *
	600 seconds (10 minutes)	06	 %0412D06%
	1800 seconds (30 minutes)	07	 %0412D07%
	3600 seconds (1 hour)	08	 %0412D08%
	10800 seconds (3 hours)	09	 %0412D09%

















### 3-7 Indication

**Power on alert:** After power-on the embedded scanner will generate an alert signal to indicate a successful self-test.

**Beeper indication:** After each successful reading, the embedded scanner will beep to indicate a good barcode reading, and its beep tone duration is adjustable.

**Volume of beeper:** This parameter can be adjusted for different level of the volume of the beeper.

**Tone of beeper:** This parameter can be adjusted for a favorite ring tone.

Multiple-scan setting			Single-scan setting
Option barcode	Option	Alpha. entry	
Power on alert  %0501M%	Disable	00	 %0501D00%
	Enable	01*	 %0501D01% *
Beeper indication  %0503M%	Disable	00	 %0503D00%
	Enable	01*	 %0503D01% *
Volume of beeper  %0505M%	Low	00	 %0505D00%
	Middle	01	 %0505D01%
	High	02*	 %0505D02% *
Tone of beeper  %0506M%	Low	00	 %0506D00%
	Middle	01	 %0506D01%
	High	02*	 %0506D02% *

  
 %END%

## 3-8 Decode illumination mode and Decode aiming pattern

**Decode illumination mode:** Enable illumination causes the embedded scanner to turn on the illumination to aid decoding. Disable illumination to turn off illumination for the embedded scanner during decoding. Better quality images could be obtained with illumination support. The effectiveness of the illumination decreases as the distance to the target increases.

**Decode aiming pattern:** When this option is enabled, the embedded scanner will project the aiming pattern during the code capture.

**Level of decode illumination:** This parameter can be adjusted for different level of decode illumination.



















### **Illumination mode of Auto-detection:**

**Always off-** Illumination LED will be always turned off.

**Enable illumination in low light conditions-** In low light conditions, the scanner will turn on illumination LED automatically to ensure normal work. While in other light conditions, the illumination LED will be turned off automatically.

**Always on-** Illumination LED will be always turned on (Default).

Note: This function is only valid in Auto-detection mode.

Multiple-scan setting			Single-scan setting
Option barcode	Option	Alpha. entry	
Decode illumination mode  %9001M%	Always Off	00	 %9001D00%
	Always On	01	 %9001D01%
	On when reading	03*	 %9001D03% *
Decode aiming pattern  %9002M%	Always off	00	 %9002D00%
	Always on	01	 %9002D01%
	On before reading	02	 %9002D02%
	On when reading	03*	 %9002D03% *
Level of decode illumination  %9003M%	Low	01	 %9003D01%
	Middle	02	 %9003D02%
	High	03*	 %9003D03% *
Illumination mode of Auto-detection  %0605M%	Always off	00	 %0605D00%
	Enable illumination in low light conditions	01	 %0605D01%
	Always on	02*	 %0605D02% *
 %END%			





















### 3-9 Single type of barcode, Multi-symbols, and Vertical centering read

**1D symbols read:** A global setting of 1D symbols readability.

**2D symbols read:** A global setting of 2D symbols readability.

**Multi-symbols read:** By setting enable, the embedded scanner allows to read multiple symbols in one image. By setting Disable, the embedded scanner will only read the symbol closest to the center area in the image.

**Vertical centering read:** By setting enable, the embedded scanner reads only the barcode centered by the aimer in vertical direction. However, the embedded scanner will read either one of two barcodes which are positioned horizontally.


Multiple-scan setting			Single-scan setting
Option barcode	Option	Alpha. entry	
1D symbols read  %1005M%	Follow respective 1D symbol setting	00*	 %1005D00% *
	All 1D Disable	01	 %1005D01%
	All 1D Enable	02	 %1005D02%
2D symbols read  %1001M%	Follow respective 2D symbol setting	00*	 %1001D00% *
	All 2D Disable	01	 %1001D01%
	All 2D Enable	02	 %1001D02%
	Only PDF417 Enable	03	 %1001D03%
	Only QR code Enable	04	 %1001D04%
	Only Data Matrix Enable	05	 %1001D05%
	Only Aztec Code Enable	07	 %1001D07%
	Only Han Xin Code Enable	08	 %1001D08%
Multi-symbols read  %1003M%	Disable	00*	 %1003D00% *
	Enable	01	 %1003D01%
Vertical centering read  %1004M%	Disable	00*	 %1004D00% *
	Enable	01	 %1004D01%
 %END%			

**Note 1 : The instruction of calibrating the aimer in vertical centering direction**

1. Scan the barcode on this page. The scanner will give three musical short beeps to indicate entering calibration mode.
2. Press the trigger of the scanner while maintaining the distance of about 15cm between the scan window of the scanner and this paper. After a few seconds, the scanner will give three short beeps to indicate a successful calibration, or a long beep to indicate a failed calibration.
3. If the calibration is failed in step 2, please repeat the steps 1-2. If it is not succeed after a multiple times of calibration, please contact your local dealer or the manufacturer for further instruction.



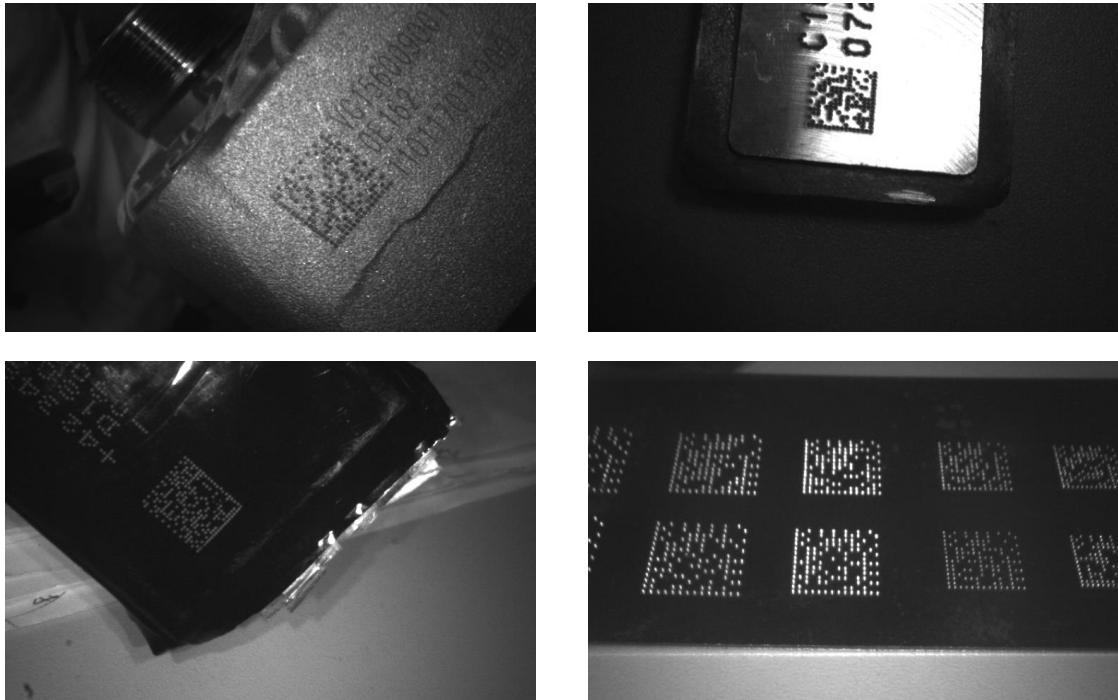
Note 2 : Scan barcode or send command to enter upgrade mode

Scan barcode to enter upgrade mode	 <b>%NMUGD</b>
Send command to enter upgrade mode	Send command 0x16 0x4D 0x0D 0x25 0x4E 0x4D 0x55 0x47 0x44 0x2E by USB virtual COM or RS232 COM.

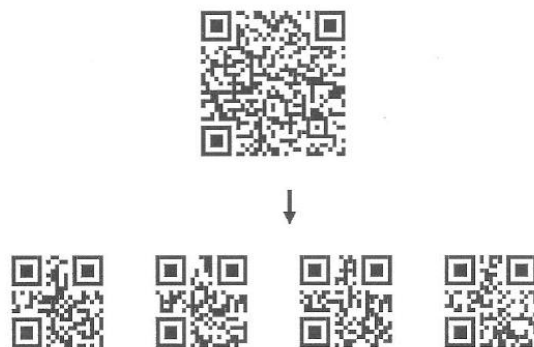


### 3-10 DPM, Structured append symbols, and Mobile screen read

**DPM format read:** By setting Enable, the embedded scanner can read 2D symbols in DPM (Direct Park Marking) format. Some barcodes in DPM format are shown below.









**Structured append symbols read:** By setting Enable, the embedded scanner will output data only when all Structured Append symbols have been decoded. The symbol types which support Structured Append include QR code, Aztec code, PDF417 and DataMatrix. The lower part of below figure shows an example of four Structured Append symbols, with the same data as that in the upper QR code symbol.



Single symbol (above) and Structured Append series of symbols (below) encoding “ABCDEFGHIJKLMNOPQRSTUVWXYZ0123456789ABCDEFGHIJKLMNOPQRSTUVWXYZ”

**Mobile screen read:** By setting enable, the embedded scanner can read barcodes on a mobile screen better. However, this will slow the reading speed of normal barcodes a little bit.

Multiple-scan setting			Single-scan setting
Option barcode	Option	Alpha. entry	
DPM format read  %1002M%	Disable	00*	 %1002D00% *
	Enable	01	 %1002D01%
Structured append symbols read  %1006M%	Disable	00*	 %1006D00% *
	Enable	01	 %1006D01%
Mobile screen read  %1007M%	Disable	00	 %1007D00%
	Enable	01*	 %1007D01% *
 %END%			

## 3-11 UPC-A

### Read:

Format

System character	Data digits (10 digits)	Check digit
------------------	-------------------------	-------------

**Check digit verification:** The check digit is optional.

**Check digit trans.:** By setting Enable, check digit will be transmitted.

**Code ID setting:** Code ID is a one-two-character string used to represent the symbol upon a succeeding reading. If you want application to transmit Code ID, you must set **Code ID transmission** to be enabled. Refer to [3-43 String transmission](#).

**Insertion group selection:** Refer to **Global insertion group selection** of [3-6 Scan mode & some global settings](#).

**Supplement digits:** The Supplement digits barcode is the supplemental 2 of 5 characters.

Format

System character	Data digits (10 digits)	Check digit	Supplement digits 2 of 5
------------------	-------------------------	-------------	--------------------------

### Truncation/Expansion:

**Truncate leading zeros** - The leading “0” digits of UPC-A data characters can be truncated when the feature is enabled.

Example: Barcode “001234567895”,

Output: “1234567895”.

**Expand to EAN-13** - It extends to 13-digits with a “0” leading digit when the feature is enabled.

Example: Barcode “001234567895”,

Output: “0001234567895”.

**Truncate system character** - The system character of UPC-A data can be truncated when the feature is enabled.



















Example: Barcode “001234567895”,

Output: “01234567895”.

**Add country code** - The country code (“0” for USA) can be added when the feature is enabled.

Example: Barcode “001234567895”,

Output: “0001234567895”.

Multiple-scan setting			Single-scan setting
Option barcode	Option	Alpha. entry	
Read  %1101M%	Disable	00	 %1101D00%
	Enable	01*	 %1101D01% *
Check digit verification  %1102M%	Disable	00	 %1102D00%
	Enable	01*	 %1102D01% *
Check digit trans.  %1103M%	Disable	00	 %1103D00%
	Enable	01*	 %1103D01% *
Code ID setting  %1104M%	00-FF <sub>16</sub> (ASCII)	00-FF <sub>16</sub>	
		<A>*	 %1104H41% *
Insert group selection  %1105M%	00-66	00-66	
		00*	 %1105D00% *
Supplement digits  %1106M%	None	00*	 %1106D00% *
	2 digits	01	 %1106D01%
	5 digits	02	 %1106D02%
	2 or 5 digits	03	 %1106D03%
Truncation/Expansion  %1107M%	None	00*	 %1107D00% *
	Truncate leading zeros	01	 %1107D01%
	Expand to EAN-13	02	 %1107D02%
	Truncate system character	03	 %1107D03%
	Add country code	04	 %1107D04%

  
 %END%

## 3-12 UPC-E

### Read:

Format

System character "0"	Data digits (6 digits)	Check digit
----------------------	------------------------	-------------

**Check digit verification:** The check digit is optional.

**Check digit trans.:** By setting Enable, check digit will be transmitted.

**Code ID setting:** Refer to [Code ID setting](#) of [3-11 UPC-A](#).

**Insertion group selection:** Refer to [Insertion group selection](#) of [3-11 UPC-A](#).

### Supplement digits:

Format

System character "0"	Data digits (6 digits)	Check digit	Supplement digits 2 of 5
----------------------	------------------------	-------------	--------------------------

### Truncation/Expansion:

**Truncate leading zeros** - The leading "0" digits of UPC-E data characters can be truncated when the feature is enabled.

Example: Barcode "00123457",

Output: "123457".

**Expand to EAN-13** - It extends to 13-digits with a "0" leading digit when the feature is enabled.

Example: Barcode "00123457",

Output: "0001234000057".

**Expand to UPC-A** - It extends to 12-digits when the feature is set to be enabled.

Example: Barcode "00123457",

Output: "001234000057".

**Truncate system character** - The system character "0" of UPC-E data can be truncated when the feature is enabled.









Example: Barcode "00123457",

Output: "0123457".

**Add country code** - The country code ("0" for USA) can be added when the feature is enabled.

Example: Barcode "00123457",

Output: "000123457".

Multiple-scan setting			Single-scan setting
Option barcode	Option	Alpha. entry	
Read  %1201M%	Disable	00	 %1201D00%
	Enable	01*	 %1201D01% *
Check digit verification  %1202M%	Disable	00	 %1202D00%
	Enable	01*	 %1202D01% *
Check digit trans.  %1203M%	Disable	00	 %1203D00%
	Enable	01*	 %1203D01% *
Code ID setting  %1204M%	00-FF <sub>16</sub> (ASCII)	00-FF <sub>16</sub>	
		<D>*	 %1204H44% *
Insert group selection  %1205M%	00-66	00-66	
		00*	 %1205D00% *
Supplement digits  %1206M%	None	00*	 %1206D00% *
	2 digits	01	 %1206D01%
	5 digits	02	 %1206D02%
	2 or 5 digits	03	 %1206D03%
Truncation/Expansion  %1207M%	None	00*	 %1207D00% *
	Truncate leading zeros	01	 %1207D01%
	Expand to EAN-13	02	 %1207D02%
	Expand to UPC-A	03	 %1207D03%
	Truncate system character	04	 %1207D04%
	Add country code	05	 %1207D05%

  
%END%

## 3-13 UPC-E1

Read:

Format

System character "1"	Data digits (6 digits)	Check digit
----------------------	------------------------	-------------

**Check digit verification:** The check digit is optional.

**Check digit trans.:** By setting Enable, check digit will be transmitted.

**Code ID setting:** Refer to [Code ID setting](#) of [3-11 UPC-A](#).

**Insertion group selection:** Refer to [Insertion group selection](#) of [3-11 UPC-A](#).

**Supplement digits:**

Format

System character "1"	Data digits (6 digits)	Check digit	Supplement digits 2 of 5
----------------------	------------------------	-------------	--------------------------

**Truncation/Expansion:**

**Expand to EAN -13** - It extends to 13-digits with "0" digits when the feature is enabled.

Example: Barcode "10012341",

Output: "0100120000031".

**Expand to UPC-A** - It extends to 12-digits when the feature is set to be enabled.

Example: Barcode "10012341",

Output: "100120000031".

**Truncate system character** - The system character "1" of UPC-E1 data can be truncated when the feature is enabled.

Example: Barcode "10012341",

Output: "0012341".

**Add country code** - The country code ("0" for USA) can be added when the feature is enabled.

Example: Barcode "10012341",

Output: "010012341".

Multiple-scan setting			Single-scan setting
Option barcode	Option	Alpha. entry	
Read  %3401M%	Disable	00*	 %3401D00% *
	Enable	01	 %3401D01%
Check digit verification  %3402M%	Disable	00	 %3402D00%
	Enable	01*	 %3402D01% *
Check digit trans.  %3403M%	Disable	00	 %3403D00%
	Enable	01*	 %3403D01% *
Code ID setting  %3404M%	00-FF <sub>16</sub> (ASCII)	00-FF <sub>16</sub>	
		<D>*	 %3404H44% *
Insert group selection  %3405M%	00-66	00-66	
		00*	 %3405D00% *
Supplement digits  %3406M%	None	00*	 %3406D00% *
	2 digits	01	 %3406D01%
	5 digits	02	 %3406D02%
	2 or 5 digits	03	 %3406D03%
Truncation/Expansion  %3407M%	None	00*	 %3407D00% *
	Expand to EAN-13	02	 %3407D02%
	Expand to UPC-A	03	 %3407D03%
	Truncate system character	04	 %3407D04%
	Add country code	05	 %3407D05%

  
 %END%



### 3-14 EAN-13

Read:

Format

Data digits (12 digits)	Check digit
-------------------------	-------------

**Check digit verification:** The check digit is optional.

**Check digit trans.:** By setting Enable, check digit will be transmitted.

**Code ID setting:** Refer to [Code ID setting](#) of [3-11 UPC-A](#).

**Insertion group selection:** Refer to [Insertion group selection](#) of [3-11 UPC-A](#).

**Supplement digits:**

Format

Data digits (12 digits)	Check digit	Supplement digits 2 of 5
-------------------------	-------------	--------------------------


**ISBN/ISSN conversion:** The ISBN (international Standard Book Number, or Bookland EAN) and ISSN (International Standard Serial Number) are two kinds of barcode for books and magazines. The ISBN is 10 digits with leading “978” and the ISSN is 8 digits with leading “977” of the EAN-13.














Example:

Barcode “9780194315104”, Output: “019431510X”.

Barcode “9771005180004”, Output: “10051805”.

**ISBN/ISSN Code ID setting:** Refer to [Code ID setting](#) of [3-11 UPC-A](#).

Multiple-scan setting			Single-scan setting
Option barcode	Option	Alpha. entry	
Read  %1301M%	Disable	00	 %1301D00%
	Enable	01*	 %1301D01% *
Check digit verification  %1302M%	Disable	00	 %1302D00%
	Enable	01*	 %1302D01% *
Check digit trans.  %1303M%	Disable	00	 %1303D00%
	Enable	01*	 %1303D01% *
Code ID setting  %1304M%	00-FF <sub>16</sub> (ASCII)	00-FF <sub>16</sub>	
		<A>*	 %1304H41% *

Multiple-scan setting			Single-scan setting
Option barcode	Option	Alpha. entry	
Insert group selection  %1305M%	00-66	00-66	
		00*	 %1305D00% *
Supplement digits  %1306M%	None	00*	 %1306D00% *
	2 digits	01	 %1306D01%
	5 digits	02	 %1306D02%
	2 or 5 digits	03	 %1306D03%
ISBN/ISSN conversion  %1307M%	Disable	00*	 %1307D00% *
	Enable	01	 %1307D01%
ISBN/ISSN Code ID setting  %1309M%	00-FF <sub>16</sub> (ASCII)	00-FF <sub>16</sub>	
		<B>*	 %1309H42% *
 %END%			

## 3-15 EAN-8

### Read:

Format

Data digits (7 digits)	Check digit
------------------------	-------------

**Check digit verification:** The check digit is optional.

**Check digit trans.:** By setting Enable, check digit will be transmitted.

**Code ID setting:** Refer to 

Code ID setting
-----------------

 of [3-11 UPC-A](#).

**Insertion group selection:** Refer to 

Insertion group selection
---------------------------

 of [3-11 UPC-A](#).

### Supplement digits:

Format

Data digits (7 digits)	Check digit	Supplement digits 2 of 5
------------------------	-------------	--------------------------

**Truncation/Expansion:** Refer to 

Truncation/Expansion
----------------------

 of [3-11 UPC-A](#).

Multiple-scan setting			Single-scan setting
Option barcode	Option	Alpha. entry	
Read  %1401M%	Disable	00	 %1401D00%
	Enable	01*	 %1401D01% *
Check digit verification  %1402M%	Disable	00	 %1402D00%
	Enable	01*	 %1402D01% *
Check digit trans.  %1403M%	Disable	00	 %1403D00%
	Enable	01*	 %1403D01% *
Code ID setting  %1404M%	00-FF <sub>16</sub> (ASCII)	00-FF <sub>16</sub>	
		<C>*	 %1404H43% *
Insert group selection  %1405M%	00-66	00-66	
		00*	 %1405D00% *
Supplement digits  %1406M%	None	00*	 %1406D00% *
	2 digits	01	 %1406D01%
	5 digits	02	 %1406D02%
	2 or 5 digits	03	 %1406D03%
Truncation/Expansion  %1407M%	None	00*	 %1407D00% *
	Truncate leading zero	01	 %1407D01%
	Expand to EAN-13	02	 %1407D02%

  
 %END%

## 3-16 Code 39 (Code 32, Trioptic Code 39)

### Read:

#### Format

Start character(*)	Data digits (variable)	Check digit (optional)	End character(*)
--------------------	------------------------	------------------------	------------------

**Check digit verification:** The check digit is optional and made as the sum module 43 of the numerical value of the data digits.

**Check digit trans.:** By setting Enable, check digit will be transmitted.

**Max./Min. code length:** Each symbol has own max./min. code length. If both setting of max./min. code length are "00", the setting of global max./min. code length is effective. The length is defined as to the actual barcode data length to be sent. Label with length exceeds these limits will be rejected. Make sure that the minimum length setting is no greater than the maximum length setting or otherwise all labels of the symbol will be readable. In particular, you can see the same value for both minimum and maximum reading length to force the fixed length barcode decoded.

**Code ID setting:** Refer to 

Code ID setting
-----------------

 of [3-11 UPC-A](#).

**Insertion group selection:** Refer to 

Insertion group selection
---------------------------

 of [3-11 UPC-A](#).

**Start/End transmission:** The start and end characters of Code 39 are "\*\*". You can transmit all data digits including two "\*\*".

**\*\* as data character:** By setting Enable, "\*\*" can be recognized as data character.

**Convert Code 39 to Code 32:** Code 32 is a variant of Code 39 used by the Italian pharmaceutical industry. Note that code 39 must be enabled in order for this parameter to function.

#### Format of Code 32

"A"(optional)	Data digits (8 digits)	Check digit
---------------	------------------------	-------------

**Code 32 Prefix "A" transmission:** By setting Enable, the prefix character "A" can be added to all Code 32 barcodes.






**Trioptic Code 39 read:** Trioptic Code 39 is a variant of Code 39 used in the marking of magnetic tapes and computer cartridges. Trioptic Code 39 symbols always contain six characters.

#### Format

Start character( \$ )	Data digits (8 digits)	End character( \$ )
-----------------------	------------------------	---------------------

**Trioptic Code 39 Start/End transmission:** The start and end characters of Trioptic Code 39 are "\$". All data digits including two "\$" can be transmitted.

Multiple-scan setting			Single-scan setting
Option barcode	Option	Alpha. entry	
Read  %1501M%	Disable	00	 %1501D00%
	Enable	01*	 %1501D01% *
Check digit verification  %1502M%	Disable	00	 %1502D00%
	Enable	01*	 %1502D01% *
Check digit trans.  %1503M%	Disable	00	 %1503D00%
	Enable	01*	 %1503D01% *
Max. code length  %1504M%	00-99	00-99	
		99*	 %1504D99% *
Min. code length  %1505M%	00-99	00-99	
		01*	 %1505D01% *
Code ID setting  %1506M%	00-FF <sub>16</sub> (ASCII)	00-FF <sub>16</sub>	
		<M>*	 %1506H4D% *
Insert group selection  %1507M%	00-66	00-66	
		00*	 %1507D00% *
Format  %1508M%	Standard	00*	 %1508D00% *
	Full ASCII	01	 %1508D01%
Start/End transmission  %1509M%	Disable	00*	 %1509D00% *
	Enable	01	 %1509D01%

Multiple-scan setting			Single-scan setting
Option barcode	Option	Alpha. entry	
“*” as data character  %1510M%	Disable	00*	 %1510D00% *
	Enable	01	 %1510D01%
Convert Code 39 to Code 32  %1511M%	Disable	00*	 %1511D00% *
	Enable	01	 %1511D01%
Code 32 prefix “A” transmission  %1512M%	Disable	00*	 %1512D00% *
	Enable	01	 %1512D01%
Trioptic Code 39 read  %1513M%	Disable	00*	 %1513D00% *
	Enable	01	 %1513D01%
Trioptic Code 39 Start/End transmission  %1514M%	Disable	00*	 %1514D00% *
	Enable	01	 %1514D01%
 %END%			

## 3-17 Interleaved 2 of 5

### Read:

Format

Data digits (variable)	Check digit (optional)
------------------------	------------------------

**Check digit verification:** The check digit is made as the sum module 10 of the numerical value of the data digits. There are two optional check digit algorithms: the specified Uniform Symbol Specification (USS) and the Optical Product Code Council (OPCC).

**Check digit trans.:** By setting Enable, check digit will be transmitted.

**Max./Min. code length:** Refer to [Max./Min. code length](#) of [3-16 Code 39 \(Code 32, Trioptic Code 39\)](#).

**Code ID setting:** Refer to [Code ID setting](#) of [3-11 UPC-A](#).

**Insertion group selection:** Refer to [Insertion group selection](#) of [3-11 UPC-A](#).



Multiple-scan setting			Single-scan setting
Option barcode	Option	Alpha. entry	
Read  %1601M%	Disable	00	 %1601D00%
	Enable	01*	 %1601D01% *
Check digit verification  %1602M%	Disable	00*	 %1602D00% *
	USS	01	 %1602D01%
	OPCC	02	 %1602D02%
Check digit trans.  %1603M%	Disable	00*	 %1603D00% *
	Enable	01	 %1603D01%
Max. code length  %1604M%	00-99	00-99	
		99*	 %1604D99% *
Min. code length  %1605M%	00-99	00-99	
		06*	 %1605D06% *
Code ID setting  %1606M%	00-FF <sub>16</sub> (ASCII)	00-FF <sub>16</sub>	
		< >*	 %1606H49% *
Insert group selection  %1607M%	00-66	00-66	
		00*	 %1607D00% *
 %END%			

### 3-18 Industrial 2 of 5

Read:

Format

Data digits (variable)

Max./Min. code length: Refer to Max./Min. code length of 3-16 Code 39 (Code 32, Trioptic Code 39).

Code ID setting: Refer to Code ID setting of 3-11 UPC-A.

Insertion group selection: Refer to Insertion group selection of 3-11 UPC-A.

Multiple-scan setting			Single-scan setting
Option barcode	Option	Alpha. entry	
Read  %1701M%	Disable	00*	 %1701D00% *
	Enable	01	 %1701D01%
Max. code length  %1702M%	00-99	00-99	
		99*	 %1702D99% *
Min. code length  %1703M%	00-99	00-99	
		04*	 %1703D04% *
Code ID setting  %1704M%	00-FF <sub>16</sub> (ASCII)	00-FF <sub>16</sub>	
		<H>*	 %1704H48% *
Insert group selection  %1705M%	00-66	00-66	
		00*	 %1705D00% *

  
 %END%

## 3-19 Matrix 2 of 5

**Read:**

Format

Data digits (variable)	Check digit (optional)
------------------------	------------------------

**Check digit verification:** The check digit is made as the sum module 10 of the numerical value of the data digits.

**Check digit trans.:** By setting Enable, check digit will be transmitted.

**Max./Min. code length:** Refer to 

Max./Min. code length
-----------------------

 of [3-16 Code 39 \(Code 32, Trioptic Code 39\)](#).

**Code ID setting:** Refer to 

Code ID setting
-----------------

 of [3-11 UPC-A](#).

**Insertion group selection:** Refer to 

Insertion group selection
---------------------------

 of [3-11 UPC-A](#).

Multiple-scan setting			Single-scan setting
Option barcode	Option	Alpha. entry	
Read  %1801M%	Disable	00	 %1801D00%
	Enable	01*	 %1801D01% *
Check digit verification  %1802M%	Disable	00*	 %1802D00% *
	Enable	01	 %1802D01%
Check digit trans.  %1803M%	Disable	00*	 %1803D00% *
	Enable	01	 %1803D01%
Max. code length  %1804M%	00-99	00-99	
		99*	 %1804D99% *
Min. code length  %1805M%	00-99	00-99	
		06*	 %1805D06% *
Code ID setting  %1806M%	00-FF <sub>16</sub> (ASCII)	00-FF <sub>16</sub>	
		<X>*	 %1806H58% *
Insert group selection  %1807M%	00-66	00-66	
		00*	 %1807D00% *

  
 %END%

## 3-20 Codabar

**Read:**

Format

Start character	Data digits (variable)	Check digit (optional)	End character
-----------------	------------------------	------------------------	---------------

**Check digit verification:** The check digit is made as the sum module 16 of the numerical value of the data digits.

**Check digit trans.:** By setting Enable, check digit will be transmitted.

**Max./Min. code length:** Refer to [Max./Min. code length](#) of [3-16 Code 39 \(Code 32, Trioptic Code 39\)](#).

**Code ID setting:** Refer to [Code ID setting](#) of [3-11 UPC-A](#).

















**Insertion group selection:** Refer to [Insertion group selection](#) of [3-11 UPC-A](#).

**Start/End Type:** Codabar has four pairs of Start/End Pattern; you may select one pair to match your application.

**Start/End transmission:** Refer to [Start/End transmission](#) of [3-16 Code 39 \(Code 32, Trioptic Code 39\)](#).

**Start/End character equality:** By setting Enable, the start and end character of a Codabar barcode must be the same.

Multiple-scan setting			Single-scan setting
Option barcode	Option	Alpha. entry	
Read  %1901M%	Disable	00	 %1901D00%
	Enable	01*	 %1901D01% *
Check digit verification  %1902M%	Disable	00*	 %1902D00% *
	Enable	01	 %1902D01%
Check digit trans.  %1903M%	Disable	00*	 %1903D00% *
	Enable	01	 %1903D01%
Max. code length  %1904M%	00-99	00-99	
		99*	 %1904D99% *
Min. code length  %1905M%	00-99	00-99	
		04*	 %1905D04% *

Multiple-scan setting			Single-scan setting
Option barcode	Option	Alpha. entry	
Code ID setting  %1906M%	00-FF <sub>16</sub> (ASCII)	00-FF <sub>16</sub>	
		<N>*	 %1906H4E% *
Insert group selection  %1907M%	00-66	00-66	
		00*	 %1907D00% *
Start/End type  %1908M%	ABCD/ABCD	00*	 %1908D00% *
	abcd/abcd	01	 %1908D01%
	ABCD/TN*E	02	 %1908D02%
	abcd/tn*E	03	 %1908D03%
Start/End transmission  %1909M%	Disable	00*	 %1909D00% *
	Enable	01	 %1909D01%
Start/End character equality  %1910M%	Disable	00*	 %1910D00% *
	Enable	01	 %1910D01%
 %END%			

## 3-21 Code 128

**Read:**

Format

Data digits (variable)	Check digit (optional)
------------------------	------------------------

**Check digit verification:** The check digit is made as the sum module 103 of all data digits.

**Check digit trans.:** By setting Enable, check digit will be transmitted.

**Max./Min. code length:** Refer to 

Max./Min. code length
-----------------------

 of [3-16 Code 39 \(Code 32, Trioptic Code 39\)](#).

**Code ID setting:** Refer to 

Code ID setting
-----------------

 of [3-11 UPC-A](#).

**Insertion group selection:** Refer to 

Insertion group selection
---------------------------

 of [3-11 UPC-A](#).

**Truncate leading zeros:** The leading "0" digits of Code 128 barcode characters can be truncated when the feature is enabled.

Multiple-scan setting			Single-scan setting
Option barcode	Option	Alpha. entry	
Read  %2001M%	Disable	00	 %2001D00%
	Enable	01*	 %2001D01% *
Check digit verification  %2002M%	Disable	00	 %2002D00%
	Enable	01*	 %2002D01% *
Check digit trans.  %2003M%	Disable	00*	 %2003D00% *
	Enable	01	 %2003D01%
Max. code length  %2004M%	00-99	00-99	
		99*	 %2004D99% *
Min. code length  %2005M%	00-99	00-99	
		01*	 %2005D01% *
Code ID setting  %2006M%	00-FF <sub>16</sub> (ASCII)	00-FF <sub>16</sub>	
		<K>*	 %2006H4B% *
Insert group selection  %2007M%	00-66	00-66	
		00*	 %2007D00% *
Truncate leading zeros  %2008M%	Disable	00*	 %2008D00% *
	All leading "0"	01	 %2008D01%
	Only the first "0"	02	 %2008D02%

  
 %END%



## 3-22 UCC/EAN 128 (GS1-128)

**Read:**

Format

Data digits (variable)	Check digit (optional)
------------------------	------------------------

**Check digit verification:** The check digit is made as the sum module 103 of all data digits.

**Check digit trans.:** By setting Enable, check digit will be transmitted.

**Max./Min. code length:** Refer to [Max./Min. code length](#) of [3-16 Code 39 \(Code 32, Trioptic Code 39\)](#).

**Code ID setting:** Refer to [Code ID setting](#) of [3-11 UPC-A](#).

**Insertion group selection:** Refer to [Insertion group selection](#) of [3-11 UPC-A](#).

**Truncate leading zeros:** Refer to [Truncate leading zeros](#) of [3-21 Code 128](#).

Multiple-scan setting			Single-scan setting
Option barcode	Option	Alpha. entry	
Read  %2501M%	Disable	00	 %2501D00%
	Enable	01*	 %2501D01% *
Check digit verification  %2502M%	Disable	00	 %2502D00%
	Enable	01*	 %2502D01% *
Check digit trans.  %2503M%	Disable	00*	 %2503D00% *
	Enable	01	 %2503D01%
Max. code length  %2504M%	00-99	00-99	
		99*	 %2504D99% *
Min. code length  %2505M%	00-99	00-99	
		01*	 %2505D01% *
Code ID setting  %2506M%	00-FF <sub>16</sub> (ASCII)	00-FF <sub>16</sub>	
		<K>*	 %2506H4B% *
Insert group selection  %2507M%	00-66	00-66	
		00*	 %2507D00% *
Truncate leading zeros  %2508M%	Disable	00*	 %2508D00% *
	All leading "0"	01	 %2508D01%
	Only the first "0"	02	 %2508D02%

  
 %END%

## 3-23 ISBT 128

**Read:**

Format

"=" or "&"	Data digits (variable)	Check digit (optional)
------------	------------------------	------------------------

**Check digit verification:** The check digit is made as the sum module 103 of all data digits.

**Check digit trans.:** By setting Enable, check digit will be transmitted.

**Max./Min. code length:** Refer to 

Max./Min. code length
-----------------------

 of [3-16 Code 39 \(Code 32, Trioptic Code 39\)](#).

**Code ID setting:** Refer to 

Code ID setting
-----------------

 of [3-11 UPC-A](#).

**Insertion group selection:** Refer to 

Insertion group selection
---------------------------

 of [3-11 UPC-A](#).

Multiple-scan setting			Single-scan setting
Option barcode	Option	Alpha. entry	
Read  %3301M%	Disable	00	 %3301D00%
	Enable	01*	 %3301D01% *
Check digit verification  %3302M%	Disable	00	 %3302D00%
	Enable	01*	 %3302D01% *
Check digit trans.  %3303M%	Disable	00*	 %3303D00% *
	Enable	01	 %3303D01%
Max. code length  %3304M%	00-99	00-99	
		99*	 %3304D99% *
Min. code length  %3305M%	00-99	00-99	
		01*	 %3305D01% *
Code ID setting  %3306M%	00-FF <sub>16</sub> (ASCII)	00-FF <sub>16</sub>	
		<K>*	 %3306H4B% *
Insert group selection  %3307M%	00-66	00-66	
		00*	 %3307D00% *

  
 %END%

## 3-24 Code 93

**Read:**

Format

Data digits (variable)	2 Check digit (optional)
------------------------	--------------------------

**Check digit verification:** The check digit is made as the sum module 47 of all data digits.

**Check digit trans.:** By setting Enable, check digit will be transmitted.

**Max./Min. code length:** Refer to [Max./Min. code length](#) of [3-16 Code 39 \(Code 32, Trioptic Code 39\)](#).

**Code ID setting:** Refer to [Code ID setting](#) of [3-11 UPC-A](#).

**Insertion group selection:** Refer to [Insertion group selection](#) of [3-11 UPC-A](#).

Multiple-scan setting			Single-scan setting
Option barcode	Option	Alpha. entry	
Read  %2101M%	Disable	00	 %2101D00%
	Enable	01*	 %2101D01% *
Check digit verification  %2102M%	Disable	00	 %2102D00%
	Enable	01*	 %2102D01% *
Check digit trans.  %2103M%	Disable	00*	 %2103D00% *
	Enable	01	 %2103D01%
Max. code length  %2104M%	00-99	00-99	
		99*	 %2104D99% *
Min. code length  %2105M%	00-99	00-99	
		01*	 %2105D01% *
Code ID setting  %2106M%	00-FF <sub>16</sub> (ASCII)	00-FF <sub>16</sub>	
		<L>*	 %2106H4C% *
Insert group selection  %2107M%	00-66	00-66	
		00*	 %2107D00% *

  
 %END%

## 3-25 Code 11

**Read:**

Format

Data digits (variable)	Check digit 1 (optional)	Check digit 2 (optional)
------------------------	--------------------------	--------------------------

**Check digit verification:** The check digit is made as the sum module 11 of all data digits.

**Check digit trans.:** By setting Enable, check digit will be transmitted.

**Max./Min. code length:** Refer to [Max./Min. code length](#) of [3-16 Code 39 \(Code 32, Trioptic Code 39\)](#).

**Code ID setting:** Refer to [Code ID setting](#) of [3-11 UPC-A](#).

**Insertion group selection:** Refer to [Insertion group selection](#) of [3-11 UPC-A](#).

Multiple-scan setting			Single-scan setting
Option barcode	Option	Alpha. entry	
Read  %2201M%	Disable	00*	 %2201D00% *
	Enable	01	 %2201D01%
Check digit verification  %2202M%	Disable	00	 %2202D00%
	1 digit	01*	 %2202D01% *
Check digit trans.  %2203M%	Disable	00*	 %2203D00% *
	Enable	01	 %2203D01%
Max. code length  %2204M%	00-99	00-99	
		99*	 %2204D99% *
Min. code length  %2205M%	00-99	00-99	
		04*	 %2205D04% *
Code ID setting  %2206M%	00-FF <sub>16</sub> (ASCII)	00-FF <sub>16</sub>	
		<V>*	 %2206H56% *
Insert group selection  %2207M%	00-66	00-66	
		00*	 %2207D00% *

  
 %END%



## 3-26 MSI/Plessey

**Read:**

Format

Data digits (variable)	Check digit 1 (optional)	Check digit 2 (optional)
------------------------	--------------------------	--------------------------

**Check digit verification:** The MSI/Plessey has one or two optional check digits. There are three methods of verifying check digits, i.e. Mod 10, Mod 10/10, and Mod 10/11. The check digit 1 and check digit 2 will be calculated as the sum module 10 or 11 of the data digits.

**Check digit trans.:** By setting Enable, check digit will be transmitted.

**Max./Min. code length:** Refer to 

Max./Min. code length
-----------------------

 of [3-16 Code 39 \(Code 32, Trioptic Code 39\)](#).

**Code ID setting:** Refer to 

Code ID setting
-----------------

 of [3-11 UPC-A](#).

**Insertion group selection:** Refer to 

Insertion group selection
---------------------------

 of [3-11 UPC-A](#).

Multiple-scan setting			Single-scan setting
Option barcode	Option	Alpha. entry	
Read  %2301M%	Disable	00*	 %2301D00% *
	Enable	01	 %2301D01%
Check digit verification  %2302M%	Disable	00*	 %2302D00% *
	1 digit (Mod 10)	01	 %2302D01%
	2 digits (Mod 10/10)	02	 %2302D02%
	2 digits (Mod 10/11)	03	 %2302D03%
Check digit trans.  %2303M%	Disable	00*	 %2303D00% *
	Enable	01	 %2303D01%
Max. code length  %2304M%	00-99	00-99	
		99*	 %2304D99% *
Min. code length  %2305M%	00-99	00-99	
		04*	 %2305D04% *
Code ID setting  %2306M%	00-FF <sub>16</sub> (ASCII)	00-FF <sub>16</sub>	
		<O>*	 %2306H4F% *
Insert group selection  %2307M%	00-66	00-66	
		00*	 %2307D00% *
 %END%			

## 3-27 UK/Plessey

Read:

Format

Data digits (variable)	2 Check digits (optional)
------------------------	---------------------------

**Check digit verification:** The UK/Plessey has one or two optional check digits. The check digit 1 and check digit 2 will be calculated as the sum module 10 or 11 of the data digits.

**Check digit trans.:** By setting Enable, check digit will be transmitted.

**Max./Min. code length:** Refer to 

Max./Min. code length
-----------------------

 of [3-16 Code 39 \(Code 32, Trioptic Code 39\)](#).

**Code ID setting:** Refer to 

Code ID setting
-----------------

 of [3-11 UPC-A](#).

**Insertion group selection:** Refer to 

Insertion group selection
---------------------------

 of [3-11 UPC-A](#).

Multiple-scan setting			Single-scan setting
Option barcode	Option	Alpha. entry	
Read  %2401M%	Disable	00*	 %2401D00% *
	Enable	01	 %2401D01%
Check digit verification  %2402M%	Disable	00	 %2402D00%
	Enable	01*	 %2402D01% *
Check digit trans.  %2403M%	Disable	00*	 %2403D00% *
	Enable	01	 %2403D01%
Max. code length  %2404M%	00-99	00-99	
		99*	 %2404D99% *
Min. code length  %2405M%	00-99	00-99	
		01*	 %2405D01% *
Code ID setting  %2406M%	00-FF <sub>16</sub> (ASCII)	00-FF <sub>16</sub>	
		<U>*	 %2406H55% *
Insert group selection  %2407M%	00-66	00-66	
		00*	 %2407D00% *

  
 %END%

### 3-28 China Post

Read:

Format

11 Data digits

Max./Min. code length: Refer to Max./Min. code length of 3-16 Code 39 (Code 32, Trioptic Code 39).

Code ID setting: Refer to Code ID setting of 3-11 UPC-A.

Insertion group selection: Refer to Insertion group selection of 3-11 UPC-A.

Multiple-scan setting			Single-scan setting
Option barcode	Option	Alpha. entry	
Read  %2601M%	Disable	00	 %2601D00%
	Enable	01*	 %2601D01% *
Max. code length  %2604M%	00-99	00-99	
		11*	 %2604D11% *
Min. code length  %2605M%	00-99	00-99	
		11*	 %2605D11% *
Code ID setting  %2606M%	00-FF <sub>16</sub> (ASCII)	00-FF <sub>16</sub>	
		<T>*	 %2606H54% *
Insert group selection  %2607M%	00-66	00-66	
		00*	 %2607D00% *
 %END%			

### 3-29 GS1 DataBar (GS1 DataBar Truncated)

GS1 DataBar Truncated is structured and encoded the same as the GS1 DataBar except that its height is reduced to a 13 modules minimum; while GS1 DataBar should have a height greater than or equal to 33 modules.

**Read:**

Format

16 Data digits

**Code ID setting:** Refer to Code ID setting of 3-11 UPC-A.

**Insertion group selection:** Refer to Insertion group selection of 3-11 UPC-A.

**Conversion:**

**UCC/EAN 128** - Refer to Code ID transmission of 3-43 String transmission, ]Cm will be identified as AIM ID.

**UPC-A or EAN-13** - Barcode beginning with a single zero as the first digit has the leading "010" stripped and the barcode reported as EAN-13. Barcode beginning with two or more zeros but not six zeros has the leading "0100" stripped and the barcode reported as UPC-A.

Multiple-scan setting			Single-scan setting
Option barcode	Option	Alpha. entry	
Read  %2701M%	Disable	00	 %2701D00%
	Enable	01*	 %2701D01% *
Code ID setting  %2702M%	00-FF <sub>16</sub> (ASCII)	00-FF <sub>16</sub>	
		<R>*	 %2702H52% *
Insert group selection  %2703M%	00-66	00-66	
		00*	 %2703D00% *
Conversion  %2704M%	None	00*	 %2704D00% *
	UCC/EAN 128	01	 %2704D01%
	UPC-A or EAN-13	02	 %2704D02%

  
 %END%

### 3-30 GS1 DataBar Limited

Read:








Format

16 Data digits

Code ID setting: Refer to Code ID setting of 3-11 UPC-A.

Insertion group selection: Refer to Insertion group selection of 3-11 UPC-A.

Conversion: Refer to Conversion of 3-31 GS1 DataBar (GS1 DataBar Truncated).

Multiple-scan setting			Single-scan setting
Option barcode	Option	Alpha. entry	
Read  %2801M%	Disable	00	 %2801D00%
	Enable	01*	 %2801D01% *
Code ID setting  %2802M%	00-FF <sub>16</sub> (ASCII)	00-FF <sub>16</sub>	
		<R>*	 %2802H52% *
Insert group selection  %2803M%	00-66	00-66	
		00*	 %2803D00% *
Conversion  %2804M%	None	00*	 %2804D00% *
	UCC/EAN 128	01	 %2804D01%
	UPC-A or EAN-13	02	 %2804D02%
 %END%			

### 3-31 GS1 DataBar Expanded

Read:

Format

Data digits (variable)

Code ID setting: Refer to Code ID setting of 3-11 UPC-A.

Insertion group selection: Refer to Insertion group selection of 3-11 UPC-A.

Conversion: Refer to Conversion of 3-31 GS1 DataBar (GS1 DataBar Truncated).

Multiple-scan setting			Single-scan setting
Option barcode	Option	Alpha. entry	
Read  %2901M%	Disable	00	 %2901D00%
	Enable	01*	 %2901D01% *
Max. code length  %2902M%	00-99	00-99	
		99*	 %2902D99% *
Min. code length  %2903M%	00-99	00-99	
		01*	 %2903D01% *
Code ID setting  %2904M%	00-FF <sub>16</sub> (ASCII)	00-FF <sub>16</sub>	
		<R>*	 %2904H52% *
Insert group selection  %2905M%	00-66	00-66	
		00*	 %2905D00% *
Conversion  %2906M%	None	00*	 %2906D00% *
	UCC/EAN 128	01	 %2906D01%
 %END%			

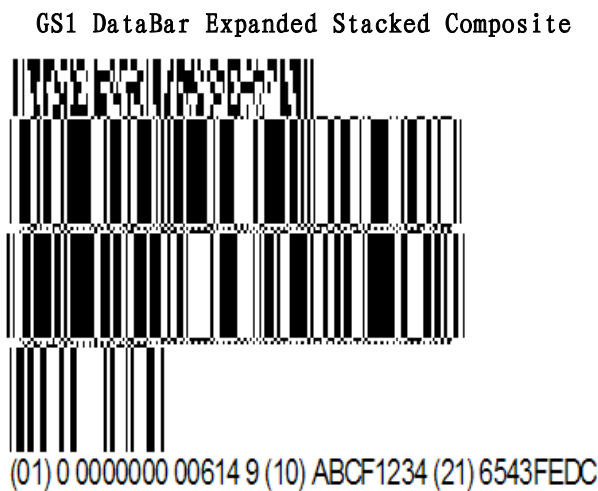


### 3-32 GS1 Composite

Note: The support for this feature is available with customized firmware version.

*GS1 Composite symbol group consists of two components: a linear component, which encodes the item's primary data; and an adjacent 2D composite component, which contains supplementary data. The linear component will be a traditional symbol of types: GS-128, EAN-8, EAN-13, UPC-A, UPC-E or DataBar.*

*The composite component will be either a CC-A (encoding up to 56 digits), a CC-B (up to 338 digits) or a CC-C (up to 2361 digits).*



#### GS1 composite version enabled:






- ✓ **Note 1-** While this feature is enabled, the decode speed will be dropped. The more versions are enabled, the more obvious influence.
- ✓ **Note 2-** If the corresponding linear 1D barcode symbol is set disable, only 2D composite data will be output after a success decode.
- ✓ **Note 3-** While this feature is set disable, if the corresponding linear 1D barcode symbol is set enable, only 1D data will be output after a success decode.
- ✓ **Note 4-** For UPC/EAN Composite, if 2D composite component is failed to decode and 1D linear

component is successful to decode, then only 1D data will be output.

- ✓ **Note 5-** If both GS-128 and DataBar Composite are set Enable, both 1D and 2D components must be successfully decoded to output both 1D and 2D data.

**GS1-128 Composite, DataBar Composite** - Two versions of GS1 Composite symbol are enabled.

**GS1-128 Composite, DataBar Composite, UPC/EAN Composite** - Three versions of GS1 Composite symbol are enabled.





Multiple-scan setting			Single-scan setting
Option barcode	Option	Alpha. entry	
GS1 composite version enabled  %3501M%	None (Disable)	00*	 %3501D00% *
	GS1-128 Composite, DataBar Composite	01	 %3501D01%
	GS1-128 Composite, DataBar Composite, UPC/EAN Composite	02	 %3501D02%
 %END%			

### 3-33 PDF417

Read:

Format

Data digits (variable)





Multiple-scan setting			Single-scan setting
Option barcode	Option	Alpha. entry	
Read  %3001M%	Disable	00	 %3001D00%
	Enable	01*	 %3001D01% *
 %END%			

### 3-34 MicroPDF417

Read:

Format

Data digits (variable)




Multiple-scan setting			Single-scan setting
Option barcode	Option	Alpha. entry	
Read  %3101M%	Disable	00*	 %3101D00% *
	Enable	01	 %3101D01%
 %END%			

### 3-35 QR Code


Read:

Format

Data digits (variable)

Multiple-scan setting			Single-scan setting
Option barcode	Option	Alpha. entry	
Read  %4001M%	Disable	00	 %4001D00%
	Enable	01*	 %4001D01% *






%END%

### 3-36 Data Matrix

Read:

Format

Data digits (variable)

Multiple-scan setting			Single-scan setting
Option barcode	Option	Alpha. entry	
Read  %4101M%	Disable	00	 %4101D00%
	Enable	01*	 %4101D01% *
 %END%			




### 3-37 Han Xin Code

Note: The support for this feature is available with customized firmware version.


**Read:**

Format

Data digits (variable)

Multiple-scan setting			Single-scan setting
Option barcode	Option	Alpha. entry	
Read  %4201M%	Disable	00*	 %4201D00% *
	Enable	01	 %4201D01%






%END%

### 3-38 Aztec Code

Read:

Format

Data digits (variable)

Multiple-scan setting			Single-scan setting
Option barcode	Option	Alpha. entry	
Read  %4301M%	Disable	00*	 %4301D00% *
	Enable	01	 %4301D01%
 %END%			






### 3-39 MicroQR Code


Note: The support for this feature is available with customized firmware version.

**Read:**

Format

Data digits (variable)

Multiple-scan setting			Single-scan setting
Option barcode	Option	Alpha. entry	
Read  %4501M%	Disable	00*	 %4501D00% *
	Enable	01	 %4501D01%

  
 %END%





### 3-40 GM code

Note: The support for this feature is available with customized firmware version.

Read:

Format

Data digits (variable)

Multiple-scan setting			Single-scan setting
Option barcode	Option	Alpha. entry	
Read  %4701M%	Disable	00	 %4701D00%
	Enable	01*	 %4701D01% *
 %END%			

### 3-41 G1-G6 & C1-C2 & FN1 substitution string setting

Format of barcode data transmission:

Prefix	Code name	Preamble	Code ID	Code length	Code data	Code ID	Postamble	Suffix
--------	-----------	----------	---------	-------------	-----------	---------	-----------	--------

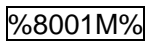



**Suffix string setting:** The <enter> key is represented indifferent ASCII when it is applied by different OS. For a Windows/DOS OS, <enter> is represented as <CR><LF> (0x0D 0x0A); for an Apple MAC OS, <enter> is represented as <CR> (0x0D); for a Linux/Unix OS, <enter> is represented as <LF> (0x0A).

**Prefix/Suffix/Preamble/Postamble string setting:**

They are appended to the data automatically when a barcode is decoded.

Example: Add a symbol of “ \$ ” as a prefix for all symbols.

Steps:

- 1) Scan the option barcode of Prefix string setting: .
- 2) Use the [8 ASCII table](#) to find the value of \$ → 24.
- 3) Scan  and .
- 4) Scan  barcode.

Scanning steps: Scan the following barcodes in order.

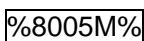





 %8001M%	 %8201M%	or	
 2	 0		
 4	 1		
 %END%	 %END%		
%8001H24%8201D01%			

**Insert G1/G2/G3/G4 string setting:** The embedded scanner offers 4 positions and 4 character strings to insert among a symbol.

Example: Set G1 string to be “AB”.

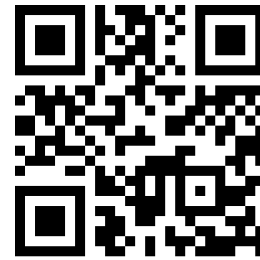
Original code data	“1 2 3 4 5 6”
Output code data	“1 2 A B 3 4 5 6”

Steps:

- 1) Scan the option barcode of Insert G1 string setting: .
- 2) Use the ASCII table to find the value of A →41, B→42
- 3) Scan ,  and , .
- 4) Scan  barcode.
- 5) Refer to [3-42 G1-G4 string position & Code ID position](#).
- 6) Refer to [3-6 Scan mode & some global settings](#).



or



%8005H4142  
%8101D02  
%0407D01%

Testing barcode:



**FN1 substitution string setting:** The FN1 character (0x1D) in an UCC/EAN128 barcode, or a Code 128 barcode, or a GS1 DataBar barcode can be substituted with a defined string.

**Single character C1/C2 replacement:** By setting, a defined character in the data string can be replaced by another defined character. The C1 and C2 replacement are applied simultaneously.

Example: Replace all the “A” character in a data string to be “B” character.

Original code data	“1 2 3 A 5 A”
Output code data	“1 2 3 B 5 B”

Steps: scan the following barcodes in order. The ASCII value for “A” is 41, and the ASCII value for “B” is 42.




















or






%8014H4142%

Testing barcode:



Multiple-scan setting			Single-scan setting
Option barcode	Option	Alpha. entry	
Prefix string setting  %8001M%	0-22 characters	00-FF <sub>16</sub>	 %8001H00% *
	None	00*	
Suffix string setting  %8002M%	0-22 characters	00-FF <sub>16</sub>	
	<ENTER>	0D0A*	
Preamble string setting  %8003M%	0-22 characters	00-FF <sub>16</sub>	 %8003H00% *
	none	00*	
Postamble string setting  %8004M%	0-22 characters	00-FF <sub>16</sub>	 %8004H00% *
	none	00*	
Insert G1 string setting  %8005M%	0-22 characters	00-FF <sub>16</sub>	 %8005H00% *
	none	00*	
Insert G2 string setting  %8006M%	0-22 characters	00-FF <sub>16</sub>	 %8006H00% *
	none	00*	
Insert G3 string setting  %8007M%	0-22 characters	00-FF <sub>16</sub>	 %8007H00% *
	none	00*	
Insert G4 string setting  %8008M%	0-22 characters	00-FF <sub>16</sub>	 %8008H00% *
	none	00*	
FN1 substitution string setting  %8009M%	0-4 characters	00-FF <sub>16</sub>	 %8009H20% *
	<SP>	20*	

Multiple-scan setting			Single-scan setting
Option barcode	Option	Alpha. entry	
Single character C1 replacement  %8014M%	0000-FFFF <sub>16</sub>	0000*	
		0000-FFFF <sub>16</sub>	
Single character C2 replacement  %8015M%	0000-FFFF <sub>16</sub>	0000*	
		0000-FFFF <sub>16</sub>	
 %END%			








### 3-42 G1-G4 string position & Code ID position

Format of barcode data transmission:

Prefix	Code name	Preamble	Code ID	Code length	Code data	Code ID	Postamble	Suffix
--------	-----------	----------	---------	-------------	-----------	---------	-----------	--------

**Insert G1/G2/G3/G4 string position:** The embedded scanner offers 4 positions to insert strings among the symbol. In case of the insertion position is greater than the length of the symbol, the insertion of string is not affected.

**Code ID position:** It is allowed to select different positions of Code ID placement.

Multiple-scan setting			Single-scan setting
Option barcode	Option	Alpha. entry	
Insert G1 string position  %8101M%	00-99	00-99	 %8101D00% *
		00*	
Insert G2 string position  %8102M%	00-99	00-99	 %8102D00% *
		00*	
Insert G3 string position  %8103M%	00-99	00-99	 %8103D00% *
		00*	
Insert G4 string position  %8104M%	00-99	00-99	 %8104D00% *
		00*	
Code ID position  %8105M%	Before code data	00*	 %8105D00% *
	After code data	01	
 %END%			

### 3-43 String transmission

*Note: The information in this chapter is closely related to 3-41 G1-G6 & C1-C2 & FN1 substitution string setting.*

**Format of barcode data transmission:**

Prefix	Code name	Preamble	Code ID	Code length	Code data	Code ID	Postamble	Suffix
--------	-----------	----------	---------	-------------	-----------	---------	-----------	--------

**Prefix transmission:** By setting Enable, prefix will be appended before the data transmitted.

**Suffix transmission:** By setting Enable, suffix will be appended before the data transmitted.

**Code name transmission:** By setting Enable, code name will be transmitted before code data.

**Preamble transmission:** By setting Enable, preamble will be appended before the data transmission

**Postamble transmission:** By setting Enable, Postamble will be appended after the data transmission.

**Code ID transmission:** By setting Enable, Code ID can be transmitted in the format of either Proprietary ID or AIM ID. Refer to [1-3 Default setting for each barcode](#).

**Code length transmission:** The length of code data string can be transmitted before the code data transmitted when Enable is selected. The length is represented by a number with two digits.

**Case conversion:** The characters within code data or the whole output string can be set in either upper case or lower case.

**FN1 substitution transmission:** The embedded scanner supports a FN1 substitution feature. The replacement string of FN1 can be chosen by user (see [3-41 G1-G6 & C1-C2 & FN1 substitution string setting](#)).








**All-non-printable-character string transmission with string setting:** By setting Enable, all string settings, e.g. Preamble transmission or Insert G1 string setting, are active for an all-non-printable-character string. Here a non-printable character means a character with ASCII value between 0x00 to 0x1F.

**Transmit the first N data characters only:** The embedded scanner supports to only transmit the first N data characters of a barcode. The number of N can be set as a digit between 1 and 99.

**Transmit the last N data characters only:** The embedded scanner supports to only transmit the last N data characters of a barcode. The number of N can be set as a digit between 1 and 99.



Multiple-scan setting			Single-scan setting
Option barcode	Option	Alpha. entry	
Prefix transmission  %8201M%	Disable	00*	 %8201D00% *
	Enable	01	 %8201D01%
Suffix transmission  %8202M%	Disable	00	 %8202D00%
	Enable	01*	 %8202D01% *
Code name transmission  %8203M%	Disable	00*	 %8203D00% *
	Enable	01	 %8203D01%
Preamble transmission  %8204M%	Disable	00*	 %8204D00% *
	Enable	01	 %8204D01%
Postamble transmission  %8205M%	Disable	00*	 %8205D00% *
	Enable	01	 %8205D01%
Code ID transmission  %8206M%	Disable	00*	 %8206D00% *
	Enable	01	 %8206D01%
Code length transmission  %8207M%	Disable	00*	 %8207D00% *
	Enable	01	 %8207D01%
Case conversion  %8208M%	Disable	00*	 %8208D00% *
	Enable	01	 %8208D01%
FN1 substitution transmission  %8209M%	Disable	00*	 %8209D00% *
	Enable	01	 %8209D01%

Multiple-scan setting			Single-scan setting
Option barcode	Option	Alpha. entry	
All-non-printable-character string transmission with string setting  %8210M%	Disable	00*	 %8210D00% *
	Enable	01	 %8210D01%
Transmit the first N data characters only  %8211M%	01-99		
	All	99*	 %8211D99% *
Transmit the last N data characters only  %8212M%	01-99		
	All	99*	 %8212D99% *

  
 %END%

## 4 Serial Communication Interface (SCI)

Note: The SCI programming commands can be used in place of the programming barcodes.

All communication between the embedded scanner and host occurs over the hardware interface lines using the Serial Communication Interface (SCI). The function of the SCI show as below:

- ✚ Maintain a bi-directional communication interface between the embedded scanner and the host.
- ✚ Allow the host to send commands to access the settings of the embedded scanner.
- ✚ Passes decoded data from the embedded scanner to the host.

In this section, the programming and query command syntax is described and examples of using commands to access the embedded scanner are presented.

## 4-1 Programming command syntax

### 4-1-1 Single-parameter setting

#### Format

Prefix	Parameter index	D/H	Value	Storage
--------	-----------------	-----	-------	---------

**Prefix:** <SYN> M <CR> (ASCII 0x16, 0x4D, 0x0D).

**Parameter index:** Each parameter has a unique 4-digit index which is similar to the option barcode listed in 6 Parameter Menus, except that there is no leading '%' and ending "M%" in the Parameter index.

**D/H:** This is used by the embedded scanner to identify the numeral system of Value. 'D' indicates a decimal number while 'H' indicates a hexadecimal number.

**Value:** This is generally a 2-digit number except for string-setting parameters, e.g. Prefix string setting.

**Storage:** A single character that specifies the storage area to which the command is applied to. An exclamation point '!' performs the command's operation on the volatile memory. A period '.' performs the command's operation on the device's non-volatile memory. Using '!' only when the setting needs to function through a single power cycle (Parameter value will be lost when power removed or the scanner enters Standby mode).

**Example1:** Set 0401->03 (decimal). The command is as following.

Prefix	Parameter index	D	Value	.
0x16 0x4D 0x0D	0x30 0x34 0x30 0x31	0x44	0x30 0x33	0x2E

**Example2:** Set 8002->0D0A (hexadecimal). The command is as following.

Prefix	Parameter index	H	Value	.
0x16 0x4D 0x0D	0x38 0x30 0x30 0x32	0x48	0x30 0x44 0x30 0x41	0x2E

## 4-1-2 Multiple-parameter setting

### Format

Prefix	Parameter index 1	D/H	Value 1	;	...	Parameter index N	D/H	Value N	Storage
--------	-------------------	-----	---------	---	-----	-------------------	-----	---------	---------

**Prefix:** Refer to Prefix of [4-1-1Single-parameter setting](#).

**Parameter index 1 to Parameter index N:** Refer to Parameter index of [4-1-1Single-parameter setting](#).

**D/H:** Refer to D/H of [4-1-1Single-parameter setting](#).

**Value 1 to Value N:** Refer to Value of [4-1-1Single-parameter setting](#).

**Storage:** Refer to Storage of [4-1-1Single-parameter setting](#).

**Example:** Set 0401->03 (decimal), 8002->0D0A (hexadecimal). The command is as following.

Prefix	Parameter index	D	Value	;	Parameter index	H	Value	.
0x16 0x4D 0x0D	0x30 0x34 0x30 0x31	0x44	0x30 0x33	0x3B	0x38 0x30 0x30 0x32	0x48	0x30 0x44 0x30 0x41	0x2E

## 4-1-3 Query command syntax

### Format

Prefix	Parameter index	^/?/*	.
--------	-----------------	-------	---

**Prefix:** Refer to Prefix of [4-1-1Single-parameter setting](#).

**Parameter index:** Refer to Parameter index of [4-1-1Single-parameter setting](#).

**^/?/\*:** Several special characters can be used to query the embedded scanner about its settings.

^ (0x5E)	Read the default value for the parameter
? (0x3F)	Read the current value for the setting.
* (0x2A)	Read the range of possible values for the parameter.

## 4-1-4 Start Decode & Stop Decode

### Start Decode

#### Format

<SYN>	T	<CR>
0x16	0x54	0x0D

Activate the embedded scanner to scan barcodes when Scan Mode is Host.

### Stop Decode

#### Format

<SYN>	U	<CR>
0x16	0x55	0x0D

Deactivate the embedded scanner to scan barcodes when Scan Mode is Host.

## 4-1-5 Return default parameters & firmware revision

### Load Defaults

#### Format

<SYN>M<CR>	%%%DEF	.
0x16 0x4D 0x0D	0x25 0x25 0x25 0x44 0x45 0x46	0x2E

Set the parameters to the default values.

### Write to Custom Defaults

#### Format

<SYN>M<CR>	%%WCDF	.
0x16 0x4D 0x0D	0x25 0x25 0x57 0x43 0x44 0x46	0x2E

Write the current parameter setting to the custom default settings.

### Restore Custom Defaults

#### Format

<SYN>M<CR>	%%RSDF	.
0x16 0x4D 0x0D	0x25 0x25 0x52 0x53 0x44 0x46	0x2E

Restore custom default settings to current settings. If failed, restore default settings.

### Firmware Version List

#### Format

<SYN>M<CR>	%%%VER	.
0x16 0x4D 0x0D	0x25 0x25 0x25 0x56 0x45 0x52	0x2E

Request the software revision string from the embedded scanner.

## 4-1-6 Get Image

### Original Image Ship

#### Format

<SYN>M<CR>	%OISHP	.
0x16 0x4D 0x0D	0x25 0x4F 0x49 0x53 0x48 0x50	0x2E

An image is taken whenever the scan operation is done. The last image is always stored in memory. The original image can be “shipped” by using the `%OISHP` command.

### Down-sampled Image Ship

#### Format

<SYN>M<CR>	%DISHP	.
0x16 0x4D 0x0D	0x25 0x44 0x49 0x53 0x48 0x50	0x2E

An image is taken whenever the scan operation is done. The last image is always stored in memory. The down-sampled image can be “shipped” by using the `%DISHP` command.

## 4-1-7 Responses

The embedded scanner responds to a serial command with one of three responses:

<ACK> (0x06)	A valid command which has been processed.
<ENQ> (0x05)	An invalid index command.
<NAK> (0x15)	A command with a valid parameter index and an invalid value.

## 4-2 Examples of setting and query commands

The following examples illustrate how a command should be constructed and transmitted to the embedded scanner.

### Example 1: Append prefix "1N" to all symbols

#### Step 1:

- 1) Set Prefix string setting to be "1N".
- 2) Look up the parameter table in 6 Parameter Menus and the ASCII table in 11 ASCII table. The target parameter index is "8001".
- 3) Its numeral system is hexadecimal, indicated by 'H'.
- 4) Using the ASCII table, "1N" is translated into "314E".
- 5) Put all above parts and then append a prefix and a storage indicator '.', thus, "<SYN>M<CR>8001H314E." is the command.
- 6) Upon receiving command, embedded scanner response with "8001H314E<ACK>".

**Host: <SYN>M<CR>8001H314E.**

<SYN>M<CR>	8001	H	314E	.
0x16 0x4D 0x0D	0x38 0x30 0x30 0x31	0x48	0x33 0x31 0x34 0x45	0x2E

**Embedded Scanner: 8001H314E**

8001	H	314E	<ACK>
0x38 0x30 0x30 0x31	0x48	0x33 0x31 0x34 0x45	0x06

#### Step 2:

- 1) Enable Prefix transmission.
- 2) Look up the parameter table in 6 Parameter Menus and the ASCII table in 11 ASCII table. The target parameter index is represented by: "8201".
- 3) The numeral system is decimal: 'D'.
- 4) The value is translated as: '0' and '1'.
- 5) Put all above parts and then append a storage indicator '.' to construct the command: "<SYN>M<CR>8201D01."
- 6) Upon receiving command, embedded scanner response with "8201D01<ACK>".

**Host: <SYN>M<CR>8201D01.**

<SYN>M<CR>	8201	D	01	.
0x16 0x4D 0x0D	0x38 0x32 0x30 0x31	0x44	0x30 0x31	0x2E

**Embedded Scanner: 8201D01<ACK>**

8201	D	01	<ACK>
0x38 0x32 0x30 0x31	0x44	0x30 0x31	0x06



## Example 2: Query current scan mode

- 1) Look up the parameter table in 6 Parameter Menus and the ASCII table in 11 ASCII table. The target parameter index is "0401".
- 2) The numeral system is decimal, thus, 'D' is used.
- 3) The value field is filled with '?'.  
The value field is filled with '?'.
- 4) Put all above parts and then append a storage indicator '.' to construct the command:  
"<SYN>M<CR>0401?.".
- 5) Upon receiving command, embedded scanner response with "0401D01<ACK>".

**Host: <SYN>M<CR>0401?.**

<SYN>M<CR>	0401	?	.
0x16 0x4D 0x0D	0x30 0x34 0x30 0x31	0x3F	0x2E

**Embedded Scanner: 0401D01<ACK>**

0401	D	01	<ACK>
0x30 0x34 0x30 0x31	0x44	0x30 0x31	0x06

## 5 Enable & Disable “NR”



**%NRON%**

### Enable “NR”

If it is enabled, while the scanner receives the STOP\_DECODE command or fails to decode a barcode within the Stand-by duration time, the scanner will transmit “NR”.



**%NROFF**

### Disable “NR” (Default)

## 6 Enable & Disable configuration by scanning barcode

Note: The setting of the below two barcodes does affect the operation of scanning the barcodes in 10 Return default parameters & firmware version.



**%PSCEN**

### **Enable configuration by scanning barcode (Default)**

The default status of the embedded scanner is enabled to scan configuration barcode.



**%PSCUN**

### **Disable configuration by scanning barcode**

Scan the above barcode to disable scanning configuration barcode, then the embedded scanner will not operate configuration by scanning configuration barcodes, but the data string of configuration barcode will be displayed. If you want to operate configuration by scanning configuration barcodes, please scan “%PSCEN” barcode.

## 7 Barcode representing non-printable character

Notes to make the following barcode:

1. According to different barcode printing software, the method of printing following barcode is different.
2. If using CODESOFT software, firstly read the information through "Help→Index→Code128→Special input syntax". Also refer to ASCII table. For example, if we wish to make "F1" barcode, select "CODE 128", then select "CODE A" type, and input "{DC1}" as data.



Up ↑



Down ↓



Left ←



Right →



Page Up



Page Down



Backspace



Tab



Home



End



Enter



Insert



Delete



F1



F2



F3



F4



F5



F6



F7



F8



F9



F10



Esc



F11



F12

## 8 ASCII table

		for keyboard wedge		for RS-232	
		0	1	0	1
L \ H	0	Null		NUL	DLE
	1	Up	F1	SOH	DC1
	2	Down	F2	STX	DC2
	3	Left	F3	ETX	DC3
	4	Right	F4	EOT	DC4
	5	PgUp	F5	ENQ	NAK
	6	PgDn	F6	ACK	SYN
	7		F7	BEL	ETB
	8	Bs	F8	BS	CAN
	9	Tab	F9	HT	EM
	A		F10	LF	SUB
	B	Home	Esc	VT	ESC
	C	End	F11	FF	FS
	D	Enter	F12	CR	GS
	E	Insert	Ctrl+	SO	RS
	F	Delete	Alt+	SI	US

Notes: The 2nd and the 3rd columns above are used for keyboard wedge only.

L \ H	2	3	4	5	6	7
	0	SP	0	@	P	`
1	!	1	A	Q	a	q
2	“	2	B	R	b	r
3	#	3	C	S	c	s
4	\$	4	D	T	d	t
5	%	5	E	U	e	u
6	&	6	F	V	f	v
7	‘	7	G	W	g	w
8	(	8	H	X	h	x
9	)	9	I	Y	i	y
A	*	:	J	Z	j	z
B	+	;	K	[	k	{
C	,	<	L	\	l	
D	-	=	M	]	m	}
E	.	>	N	^	n	~
F	/	?	O	_	o	DEL

Example: ASCII “A” = “41”.

## 9 Test symbols

UPC-A



UPC-E



UPC-E1

(Default setting: Disable)



EAN-13



ISBN/ISSN



EAN-8



Code 39



Code 32



A908765439

Trioptic Code 39

(Default setting: Disable)



Interleaved 2 of 5



Industrial 2 of 5

(Default setting: Disable)



Matrix 2 of 5



Codabar



a01+-.:/\$89a

Code 128



01AZ[+~\*/]za98

UCC/EAN 128



01AZ[]+~\*az54

ISBT 128



=1234 56789

Code 93



01AZ+~/\*az89

Code 11

(Default setting: Disable)



123456789-0

MSI/Plessey

(Default setting: Disable)



0123456789

UK/Plessey

(Default setting: Disable)



01ABEF89

China Post



54789632145

GS1 DataBar (GS1 DataBar Truncated)



1234567890123

GS1 DataBar Limited



987654321012

GS1 DataBar Expanded



Ab\_09+yZ

PDF417



12=890ab-+%xyz

MicroPDF417



0239+-mdo

QR code



1234567890ABCD-+()&\*%^\#@#\$!XYZ

Data Matrix



123890abc-+&\*%^\!mdo

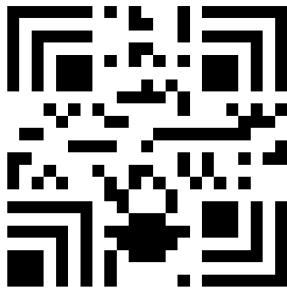


**Aztec Code**  
(Default setting: Disable)



12345678901234567890

**Han Xin Code**  
(Default setting: Disable)



SAMPLE

Micro QR  
(Default setting: Disable)



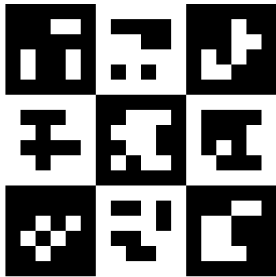
0123456789MINDEO

CodaBlock F Code



0123456789

GM Code



0123456789MINDEO

## 10 Return default parameters & firmware version



%%%DEF

### Restore Factory Defaults

Scan this barcode to restore the factory default values.



%%WCDF

### Write to Custom Defaults

Store the current scanner settings as custom defaults.



%%RSDF

### Restore Custom Defaults

Restore the scanner's custom default settings. If no custom defaults were set, restore the factory default values.



%%%VER

### Firmware Version List

Scan this barcode to display the firmware version.

# 11 Configuration alphanumeric entry barcode



To finish parameter setting, please scan the bar code below.

